



U.S. Department
of Veterans Affairs

SECTION 3.3

MANDATORY VA POLICY & DIRECTIVE SIGNAGE DRAWINGS



Introduction

This section is comprised of policy and regulations that are REQUIRED to be posted by applicable codes, laws, and VA Policy Directive. Only mandatory postings are included in this section. Other types of signs required by code, regulatory bodies, or VA Policy Directive are found in each respective section of this Manual (Section 3.1, Section 3.2, and Section 3.5).

The following drawings provide general design intent and do not function as fabrication-ready shop drawings.

Guidelines

- This section covers the mandatory postings at the time of publication. VA Policy Directives constantly evolve and change, so check for any VA Policy Directives issued after the date of this publication that require signage to be posted.
- Component-based sign systems used should match the established sign standard specific to the individual facility.
- Please review [Section 2.3 Mandatory VA Policy & Directive Signage Guidelines](#) which contains information regarding Planning, Programming, Construction, and Installation prior to starting signage projects.
- Creative example configurations of mandatory entrance signs can be found at the end of this section.

Requirements

- The content for each mandatory posting in this section is not open to modification or revision unless specifically stated in drawing notes.
- All Mandatory VA Policy & Directives signs are to be fabricated, located, and installed per the specifications contained in this section and [Section 2.3](#).
- The use of component-based sign systems is required at VA facilities except for door-mounted signs (see [Sections 2.1.5 & 2.1.6](#)). The exact materials, parts, finishes, and dimensions of a component sign system will vary by manufacturer.

Updatable Inserts

- To increase durability and moisture resistance, updatable inserts should be printed on synthetic paper or clear acetate sheets. Standard printer paper can absorb moisture causing wrinkles and yellowing over time.



Sign Designations

Each sign in the program manual has been given a specific sign type number designation. This designation provides a common description that can be referenced when programming a site and ordering signs. The following explains how the sign type designations are derived.

Note: This Section includes both interior and exterior Mandatory VA Policy & Directive signs despite being attributed with the prefix "IN".

For the sake of consistency amongst all VA official documentation, no sign designation shall change within this manual without the express written consent of the VA, followed by a VA Design Alert that is distributed on a monthly basis.

IN - 02 .06 A

- I** Designates an interior sign.
- N** Identifies that the sign is non-illuminated.
- 02** Two-digit numbers identify a particular sign type family.
- .01** The two-digit number following the period identifies a specific sign within the sign family.
- A** The letter designates a specific sign configuration, version, or layout for graphics.



Sign Overview

Mandatory VA Policy & Directive Signage Drawings

IN-02.01
Consent to Inspection Sign

IN-02.10
No Weapons Notice Sign - Interior

IN-02.03
No Weapons Permitted Sign

IN-02.01 **IN-02.10** **IN-02.03**

IN-02.14
Video Surveillance Sign

IN-02.15
Service Dogs Sign

IN-02.02
No Smoking, No Vaping Sign

IN-02.14 **IN-02.15** **IN-02.02**



Sign Overview

Mandatory VA Policy & Directive Signage Drawings

Grouped Signs

Signs may be combined as follows:

- IN-02.01 - Consent to Inspection
- IN-02.10 - No Weapons Notice
- IN-02.03 - No Weapons Policy

- IN-02.14 – Video Surveillance
- IN-02.15 – Service Dogs
- IN-02.02 – No Smoking, No Vaping

These signs can be grouped together in one display or broken into two displays of 3 signs each, following the same sequence.

Refer to the [Layout Examples](#) at the end of this section for how these signs and others may be configured on a wall.

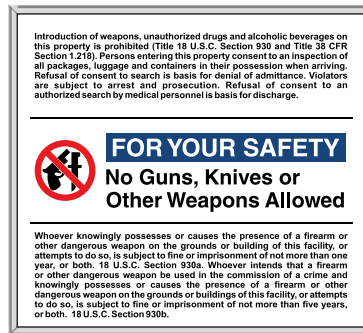

Grouped Signs: Multiple Panels



Grouped Signs: Single Panel

IN-02.04.01

Business Hours & Video Surveillance Sign - Vinyl

IN-02.04.02

Business Hours & Video Surveillance Sign - Exterior

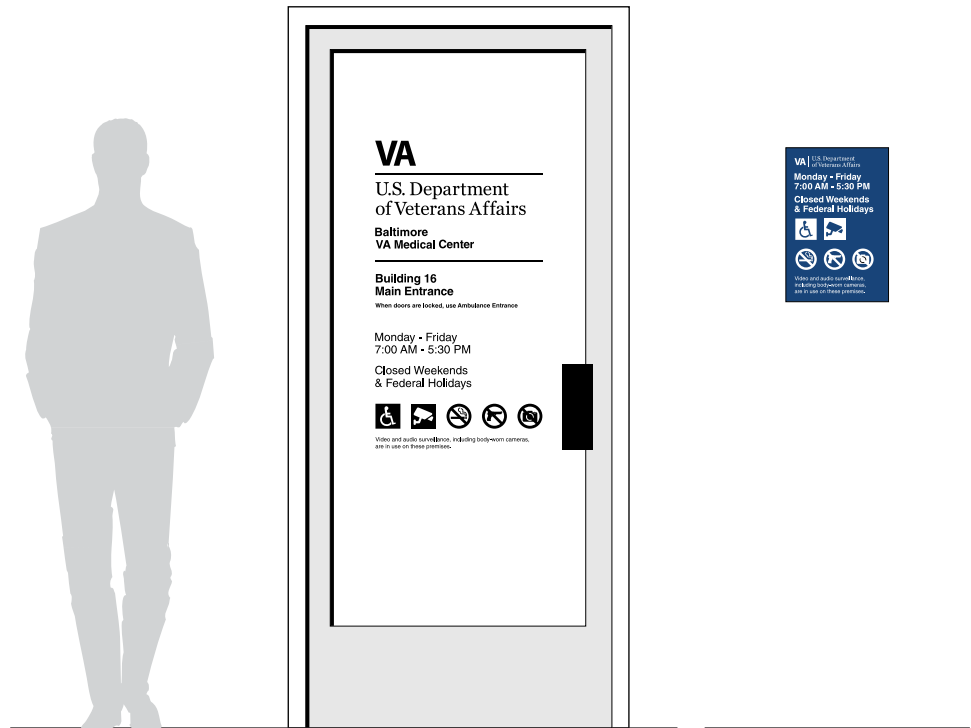

IN-02.04.01

IN-02.04.02



Sign Overview

Mandatory VA Policy & Directive Signage Drawings

IN-02.04.03

Business Hours Sign - Interior

IN-02.05

Notice of Weapons Search Sign

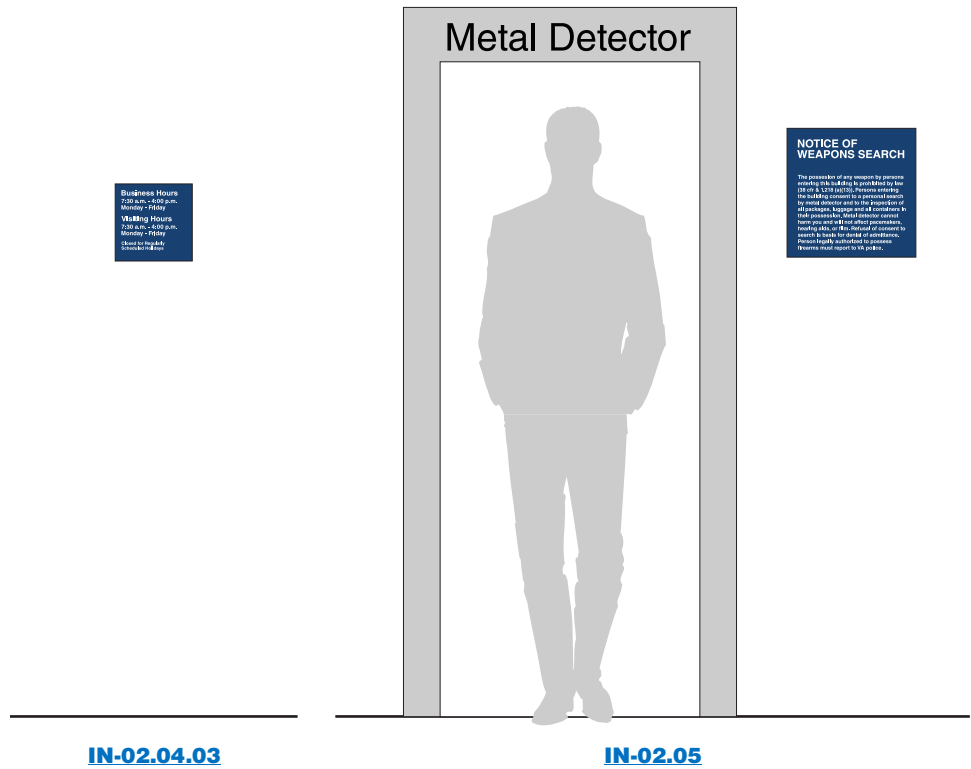

IN-02.06

Parking Restrictions Sign

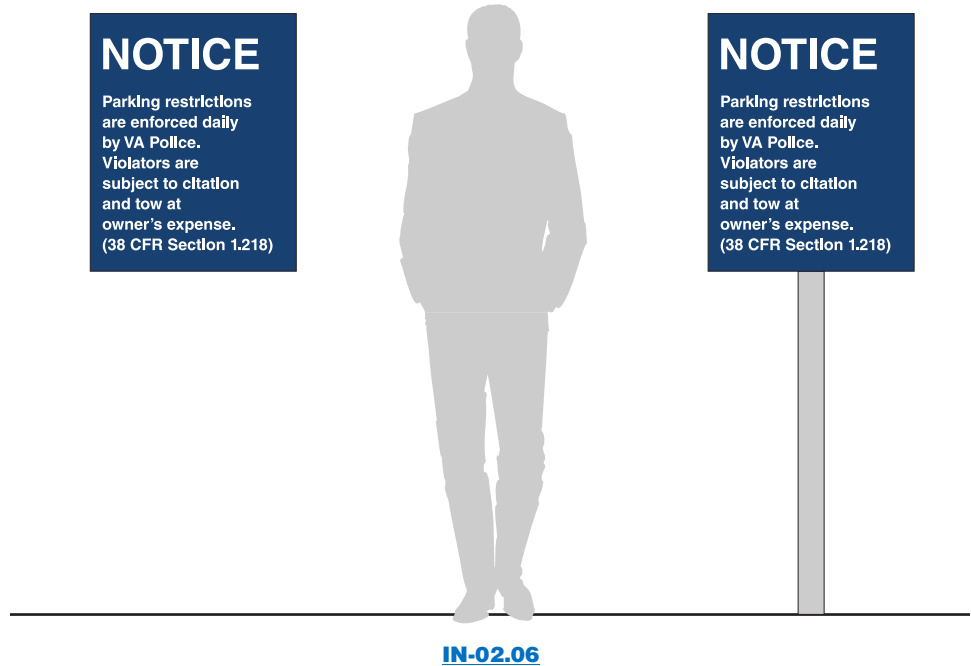

Sign Overview

Mandatory VA Policy & Directive Signage Drawings

IN-02.07.01

Rights and Responsibilities of VA Patients

IN-02.07.02

Rights and Responsibilities of Family Members of VA Patients

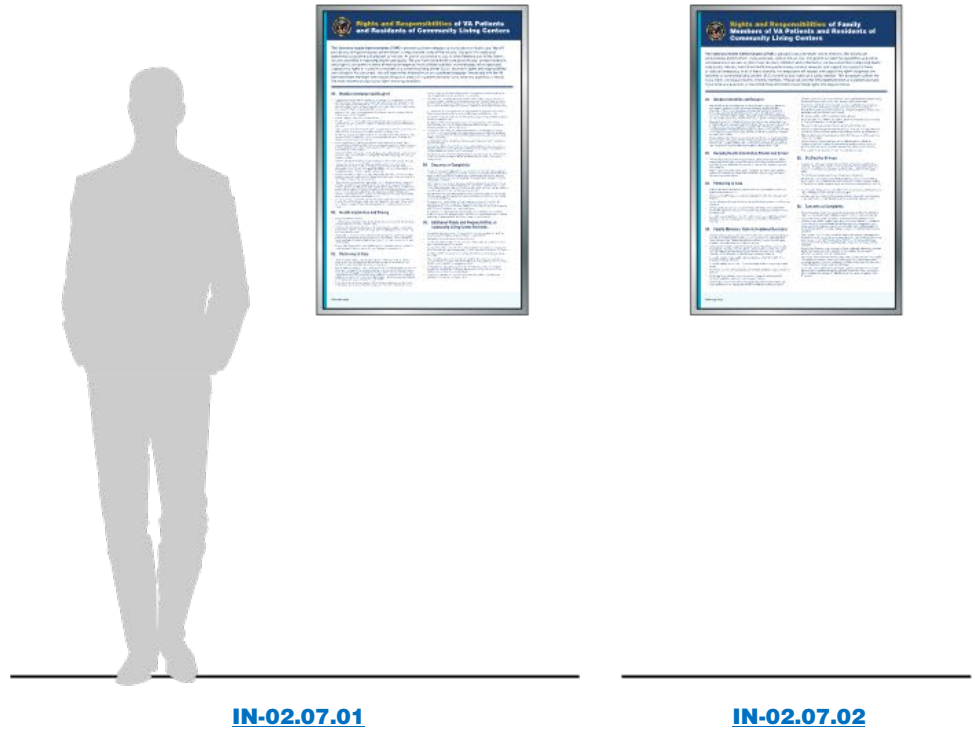

IN-02.07.01

IN-02.07.02

IN-02.07.03

Policies and Directives

IN-02.07.04

Notice of Privacy Practices

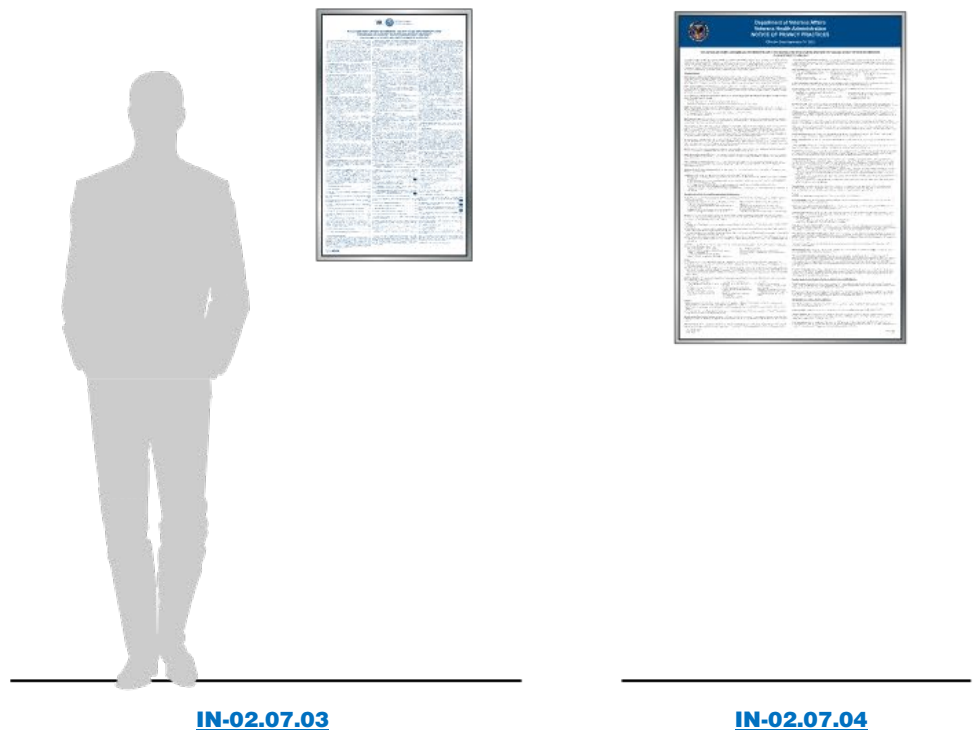

IN-02.07.03

IN-02.07.04



Sign Overview

Mandatory VA Policy & Directive Signage Drawings

IN-02.08

Anti-Sexual Harassment /
Anti-Sexual Assault

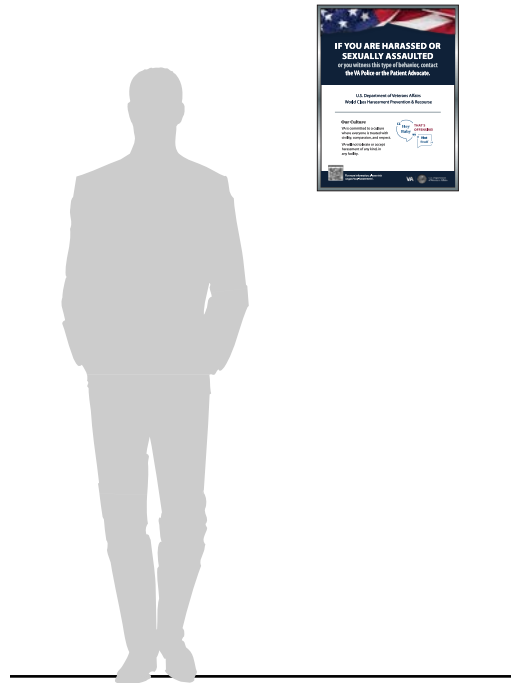

IN-02.08

IN-02.11

No Weapons Sign Large - Exterior

IN-02.12

No Weapons Sign Small - Exterior



IN-02.11

IN-02.12



Sign Overview

Mandatory VA Policy & Directive Signage Drawings

IN-02.13
Video Surveillance Sign - Exterior

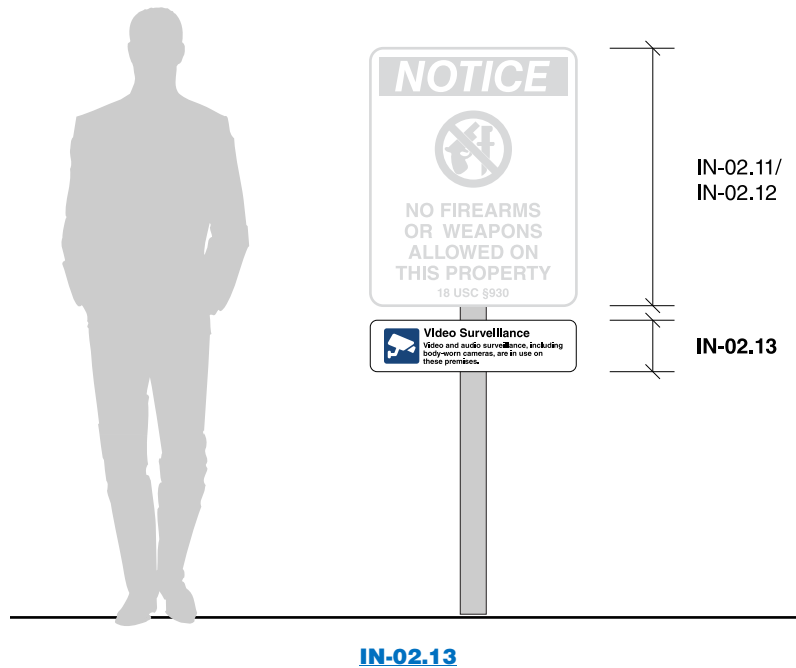

IN-02.16
No Trespassing Sign

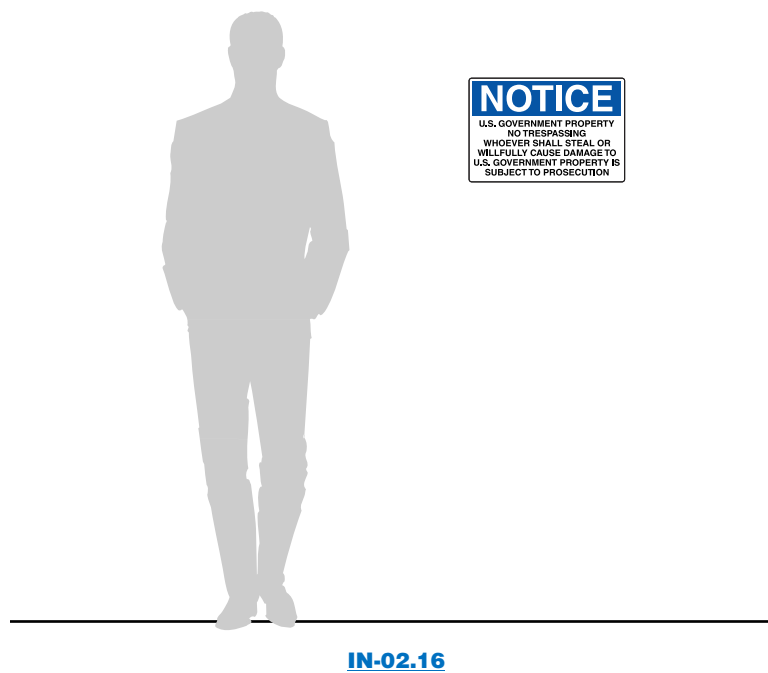

IN-02.01

Mandatory VA Policy & Directive Signage Drawings

Consent to Inspection Sign

Size

Sign Face:
6" High x 20" Wide
(152.4 mm H x 508 mm W)

Description

"Consent to Inspection" sign is required to be placed on an interior wall at all public entrances to a building.

Message Configuration

Refer to message layout drawing for dimensions. When combining 6" x 20" policy signs into one display, add a 1/16" rule line to separate each sign visually.

Sign Components

Component based signage system

Graphic Process

Direct digital print on second surface or silk-screened

Colors

Refer to the chart in the Appendix.

Typography

Helvetica Bold

Mounting

Preferred: Concealed mechanical fasteners
Alternate: Double-sided VHB foam tape and silicone adhesive

Installation

Display the 6" x 20" policy signs in the following sequence:

- IN-02.01 - Consent to Inspection
- IN-02.10 - No Weapons Notice
- IN-02.03 - No Weapons Policy

- IN-02.14 – Video Surveillance
- IN-02.15 – Service Dogs
- IN-02.02 – No Smoking, No Vaping

These signs can be grouped together in one display or broken into two displays of 3 signs each, following the same sequence.

Coordinate placement with other policy signs required at entrances.

See example layouts at the end of this section.

Introduction of weapons, unauthorized drugs and alcoholic beverages on this property is prohibited (Title 18 U.S.C. Section 930 and Title 38 CFR Section 1.218). Persons entering this property consent to an inspection of all packages, luggage and containers in their possession when arriving. Refusal of consent to search is basis for denial of admittance. Violators are subject to arrest and prosecution. Refusal of consent to an authorized search by medical personnel is basis for discharge.

Message Layout

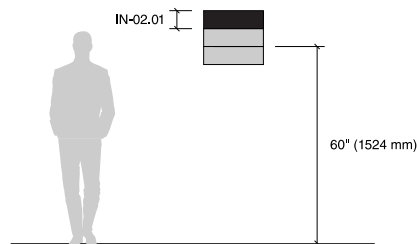

Adjust installation height as needed to coordinate with other policy signs.



IN-02.01

Mandatory VA Policy & Directive Signage Drawings

Consent to Inspection Sign

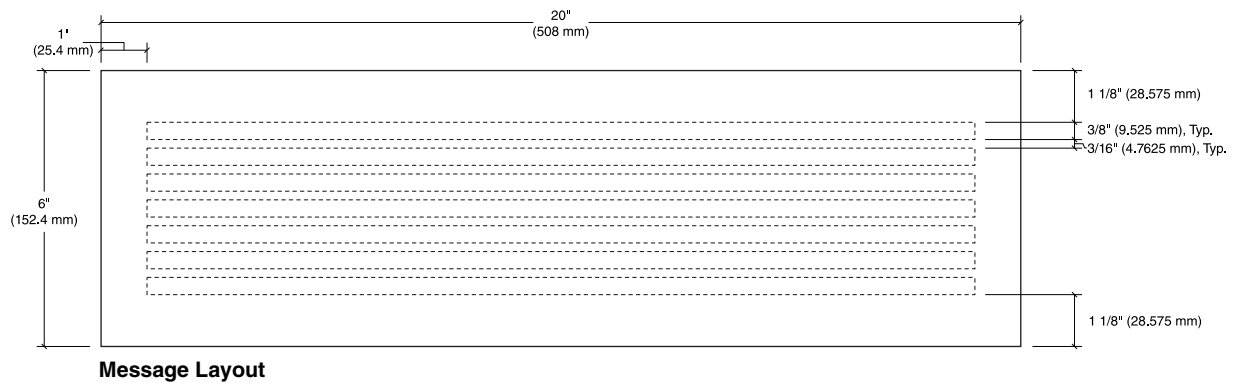

IN-02.02

Mandatory VA Policy & Directive Signage Drawings

No Smoking, No Vaping Sign

Size

Sign Face:
6" High x 20" Wide
(152.4 mm H x 508 mm W)

Description

"No Smoking, No Vaping" sign is required to be placed on an interior wall at all public entrances to a building.

Message Configuration

Refer to message layout drawing for dimensions. When combining 6" x 20" policy signs into one display, add a 1/16" rule line to separate each sign visually.

Sign Components

Component based sign system

Graphic Process

Direct digital print on second surface or silk-screened

Colors

Refer to the chart in the Appendix.

Typography

Helvetica Bold

Mounting

Preferred: Concealed mechanical fasteners
Alternate: Double-sided VHB foam tape and silicone adhesive

Installation

Display the 6" x 20" policy signs in the following sequence:

- IN-02.01 - Consent to Inspection
- IN-02.10 - No Weapons Notice
- IN-02.03 - No Weapons Policy

- IN-02.14 – Video Surveillance
- IN-02.15 – Service Dogs
- IN-02.02 – No Smoking, No Vaping

These signs can be grouped together in one display or broken into two displays of 3 signs each, following the same sequence.

Coordinate placement with other policy signs required at entrances.

See example layouts at the end of this section.

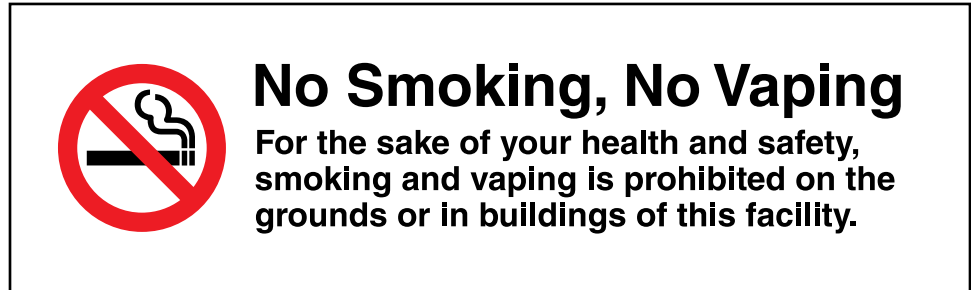

Message Layout

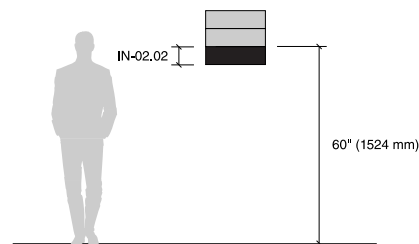

Adjust installation height as needed to coordinate with other policy signs.



IN-02.02

Mandatory VA Policy & Directive Signage Drawings

No Smoking or Vaping Sign

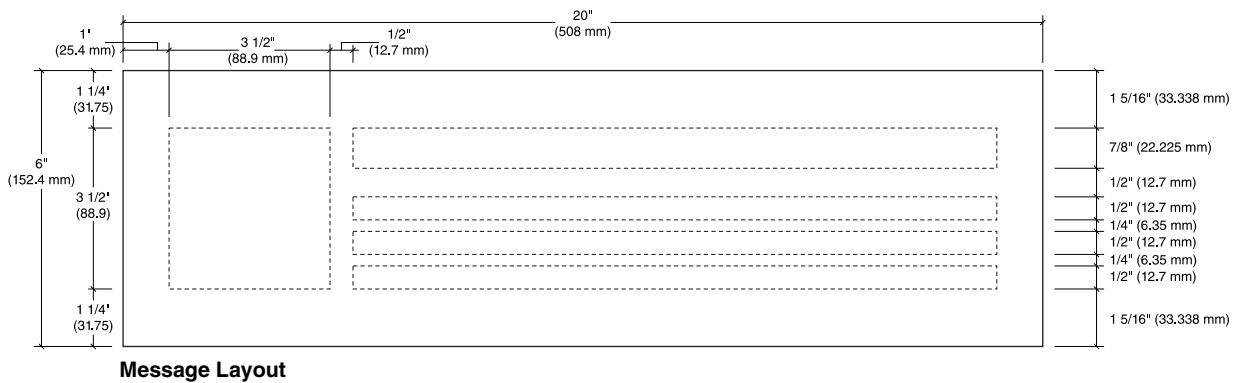

IN-02.03

Mandatory VA Policy & Directive Signage Drawings

No Weapons Permitted Sign

Size

Sign Face:
6" High x 20" Wide
(152.4 mm H x 508 mm W)

Description

"No Weapons Permitted" sign is required to be placed on an interior wall at all public entrances to a building.

Message Configuration

Refer to message layout drawing for dimensions. When combining 6" x 20" policy signs into one display, add a 1/16" rule line to separate each sign visually.

Sign Components

Component based sign system

Graphic Process

Direct digital print on second surface or silk-screened

Colors

Refer to the chart in the Appendix.

Typography

Helvetica Bold

Mounting

Preferred: Concealed mechanical fasteners
Alternate: Double-sided VHB foam tape and silicone adhesive

Installation

Display the 6" x 20" policy signs in the following sequence:

- IN-02.01 - Consent to Inspection
- IN-02.10 - No Weapons Notice
- IN-02.03 - No Weapons Policy

- IN-02.14 – Video Surveillance
- IN-02.15 – Service Dogs
- IN-02.02 – No Smoking, No Vaping

These signs can be grouped together in one display or broken into two displays of 3 signs each, following the same sequence.

Coordinate placement with other policy signs required at entrances.

See example layouts at the end of this section.

Whoever knowingly possesses or causes the presence of a firearm or other dangerous weapon on the grounds or building of this facility, or attempts to do so, is subject to fine or imprisonment of not more than one year, or both. 18 U.S.C. Section 930a. Whoever intends that a firearm or other dangerous weapon be used in the commission of a crime and knowingly possesses or causes the presence of a firearm or other dangerous weapon on the grounds or buildings of this facility, or attempts to do so, is subject to fine or imprisonment of not more than five years, or both. 18 U.S.C. Section 930b.

Message Layout

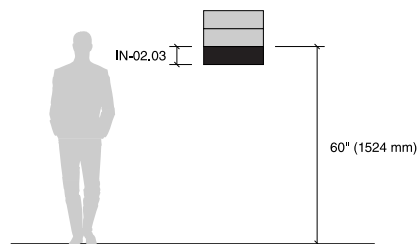

Adjust installation height as needed to coordinate with other policy signs.



IN-02.03

Mandatory VA Policy & Directive Signage Drawings

No Weapons Permitted Sign

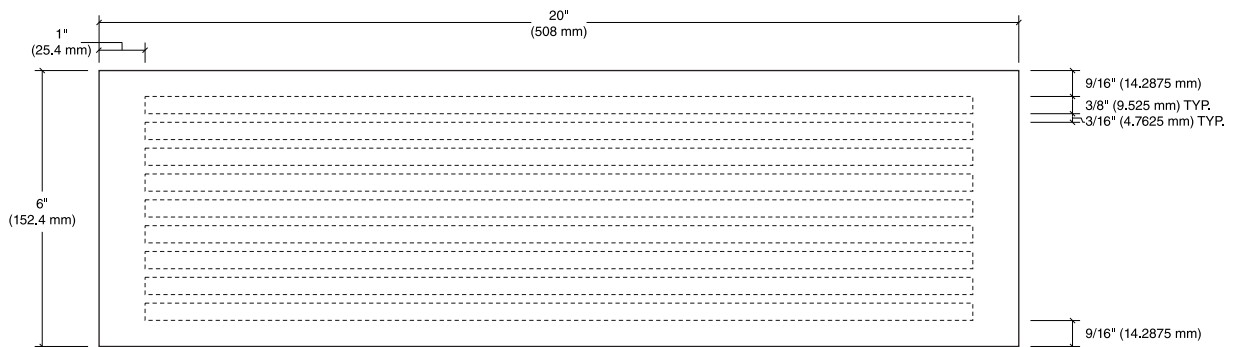

Message Layout



IN-02.04.01

Mandatory VA Policy & Directive Signage Drawings

Business Hours & Video Surveillance Sign – Vinyl

Size

Sign Characters: See layout

Overall Sign Height:

5'-6" High (1676.4 mm H)

Description

A "Business Hours" sign is required to be placed at public entrances to a building. In addition, the facility must notify individuals if they are subject to photography, digital recording or video or audio recording. This sign covers both requirements. Two options are provided:

IN-02.04.01 - Glass Mount Option

IN-02.04.02 - Wall Mount Option

Message Configuration

Refer to message layout drawing for dimensions.

Note: Hours and days of operation are to be established on a facility-by-facility bases.

Sign size, color and layout are not mandated and can be adjusted to appropriately fit use case.

Graphic Process

Surface applied white vinyl

Colors

Text: White

Do not use colored vinyl.

Refer to the chart in the Appendix.

Typography

Helvetica

Installation

On storefront: 5'-6" (1676.4 mm) to top of sign, at public entrances.

36 3/4"
(933.45 mm)

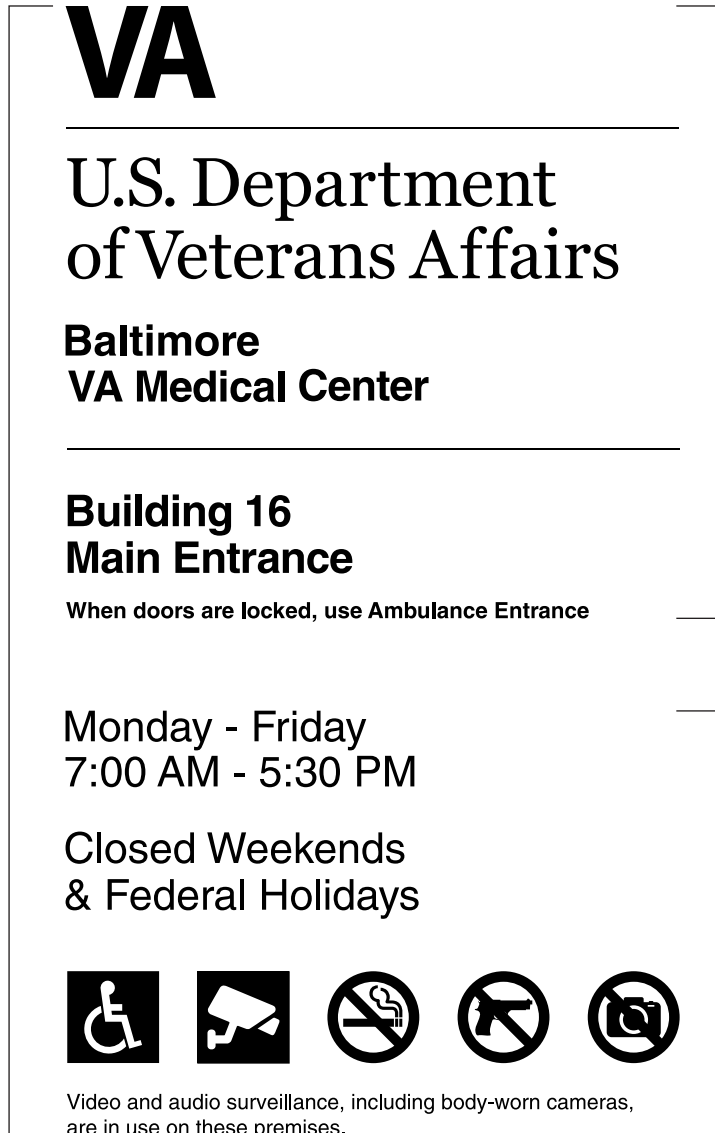

EN-14
Optional

3" (76.2 mm)

IN-02.04.01
Required

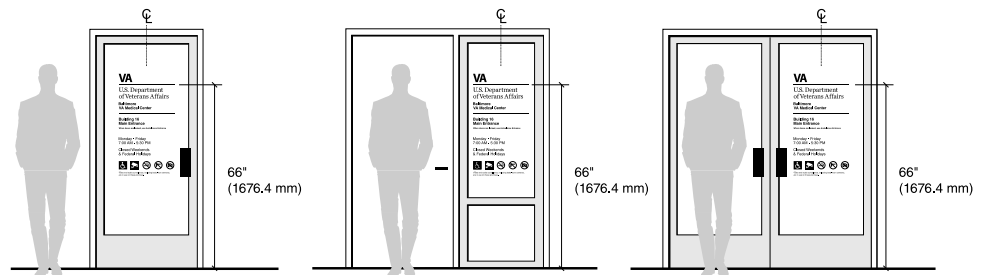

IN-02.04.01

Mandatory VA Policy & Directive Signage Drawings

Business Hours & Video Surveillance Sign – Vinyl



IN-02.04.02

Mandatory VA Policy & Directive Signage Drawings

Business Hours & Video Surveillance Sign – Exterior

Size

Sign Face:
18" High x 12" Wide
(457.2 mm H x 304.8 mm W)

Description

A "Business Hours" sign is required to be placed at public entrances to a building. In addition, the facility must notify individuals if they are subject to photography, digital recording or video or audio recording. This sign covers both requirements. Two options are provided:

IN-02.04.01 - Glass Mount Option
IN-02.04.02 - Wall Mount Option

Message Configuration

Refer to message layout drawing for dimensions.

Note: Hours and days of operation are to be established on a facility-by-facility bases.

Sign size, color and layout are not mandated and can be adjusted to appropriately fit use case.

Sign Components

Aluminum panel

Graphic Process

Surface applied white reflective vinyl.

Colors

Refer to the chart in the Appendix.

Typography

Helvetica Bold

Mounting

Mechanical fasteners

Installation

On wall: 60" (1524 mm) to center of sign, at public entrances.

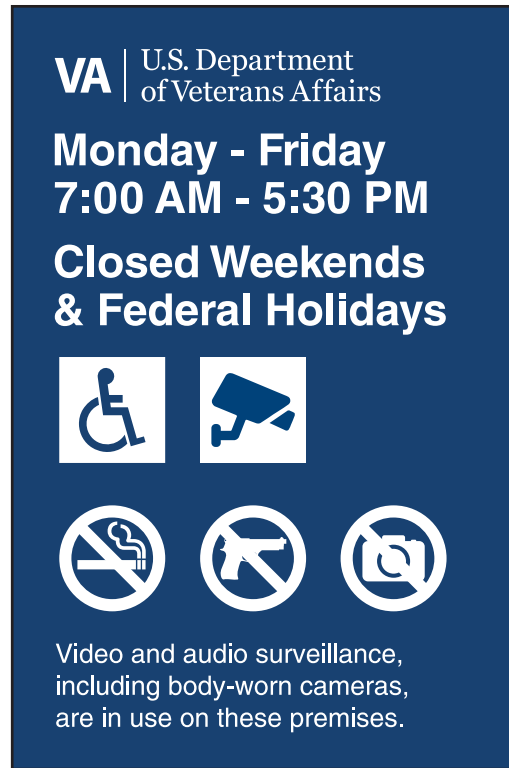

Message Layout

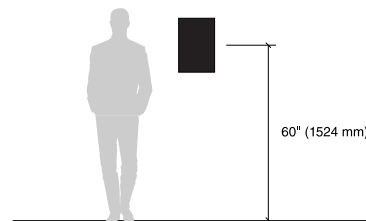

Business Hours & Video Surveillance Sign – Exterior

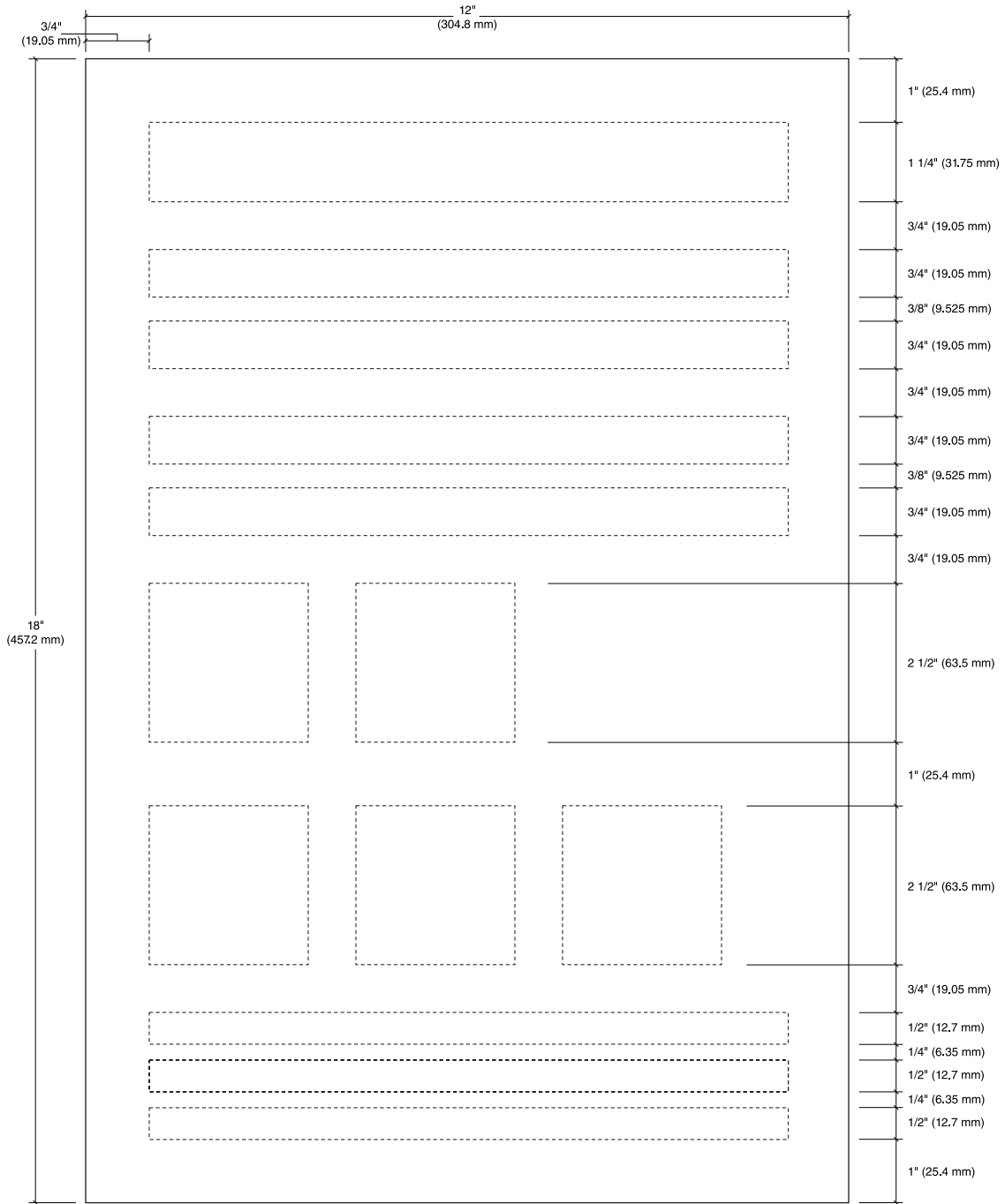

Message Layout



IN-02.04.03

Mandatory VA Policy & Directive Signage Drawings

Business Hours Sign – Interior

Size

Sign Face:
9" High x 9" Wide
(228.6 mm H x 228.6 mm W)

Description

"Business Hours" sign required to be placed at interior locations where hours of operations differ from the rest of the campus.

Message Configuration

Refer to message layout drawing for dimensions.

Note: Hours and days of operation are to be established on a case-by-case basis.

Sign size, color and layout are not mandated and can be adjusted to appropriately fit use case.

Sign Components

Component based sign system

Graphic Process

Direct digital print on second surface or silk-screened

Colors

Refer to the chart in the Appendix.

Typography

Helvetica Bold

Mounting

Preferred: Concealed mechanical fasteners

Alternate: Double-sided VHB foam tape and silicone adhesive

Installation

On wall: 5'-0" (1524 mm) to top of sign, at the entrance to the department / location where hours differ from the rest of the campus.



Message Layout

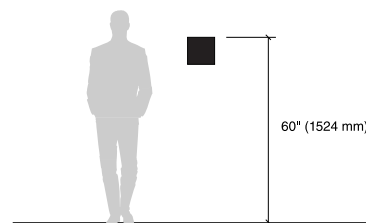

IN-02.04.03

Mandatory VA Policy & Directive Signage Drawings

Business Hours Sign – Interior

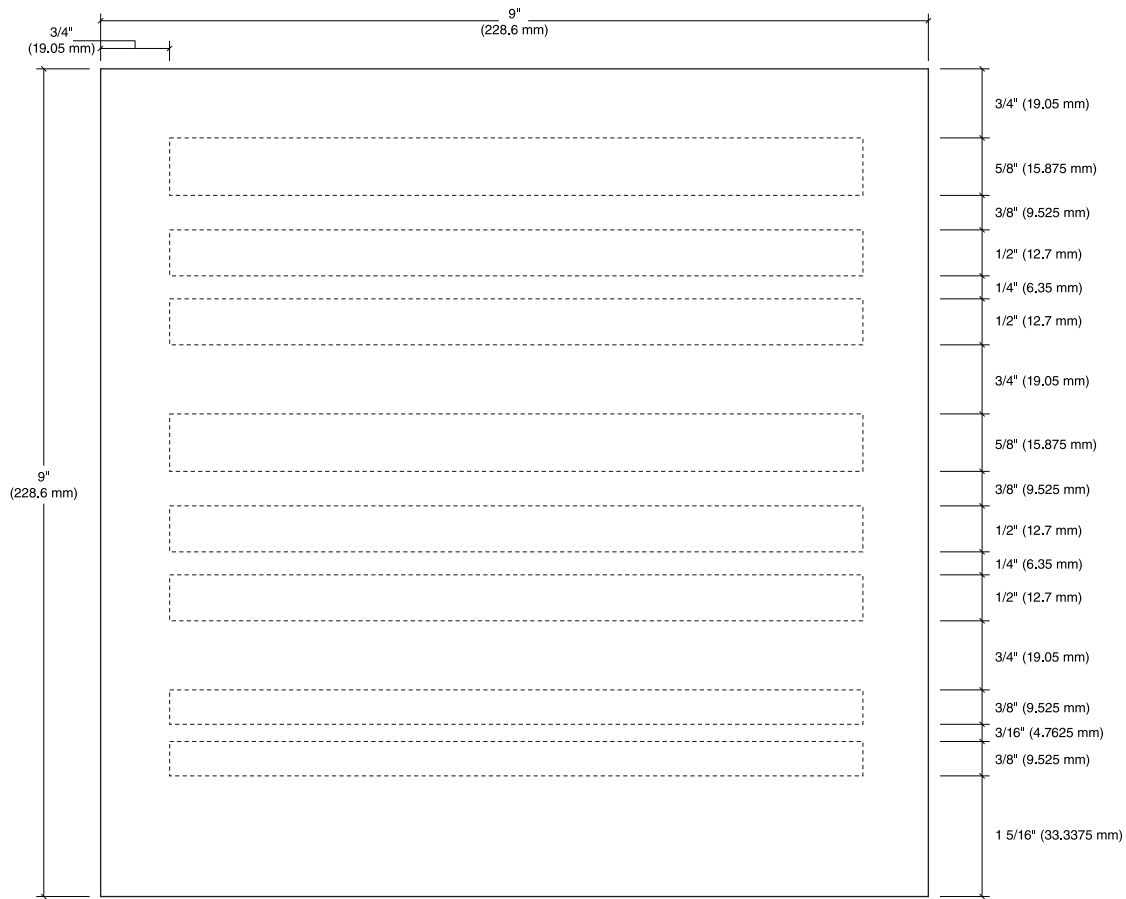

Message Layout



IN-02.05

Mandatory VA Policy & Directive Signage Drawings

Notice of Weapons Search Sign

Size

Sign Face:
15" High x 15" Wide
(381 mm H x 381 mm W)

Description

This sign only required at metal detector screening devices and is to be installed next to the detector and in a location that is visible before passing through the machine.

Message Configuration

Refer to message layout drawing for dimensions.

Sign Components

Component based sign system

Graphic Process

Direct digital print on second surface or silk-screened

Colors

Refer to the chart in the Appendix.

Typography

Helvetica Bold

Mounting

Preferred: Concealed mechanical fasteners

Alternate: Double-sided VHB foam tape and silicone adhesive

Installation

On wall: 60" (1524 mm) to center of sign, adjacent to metal detector/screening device

NOTICE OF WEAPONS SEARCH

The possession of any weapon by persons entering this building is prohibited by law (38 cfr & 1.218 (a)(13)). Persons entering the building consent to a personal search by metal detector and to the inspection of all packages, luggage and all containers in their possession. Metal detector cannot harm you and will not affect pacemakers, hearing aids, or film. Refusal of consent to search is basis for denial of admittance. Person legally authorized to possess firearms must report to VA police.

Message Layout

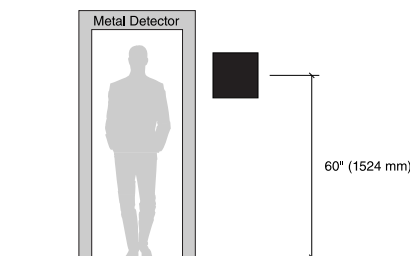

IN-02.06

Mandatory VA Policy & Directive Signage Drawings

Parking Restrictions Sign

Size

Sign Face: 30" High x 24" Wide x 1/8" Thick (762 mm H x 609.6 mm W x 3.175 mm T)

Alternate size for areas with limited space:

24" High x 18" Wide x 1/8" Thick (609.6 mm H x 457.2 mm W x 3.175 mm T)

Description

Parking restriction sign is required to be placed at all public vehicular entrances to a VA facility.

Sign is similar to sign type EN-05.01. See [2.5 Exterior Signs](#) for construction and installation details.

Message Configuration

Refer to message layout drawing for dimensions.

Graphic Process

Surface applied reflective vinyl

Colors

Refer to the chart in the Appendix.

Installation

Position sign so drivers have a clear, unobstructed view of the sign.

When placing this type of sign near curbs or parking places, be sure the sign is set far enough back that over hanging front and rear of automobiles do not come in contact with the signpost.



Message Layout

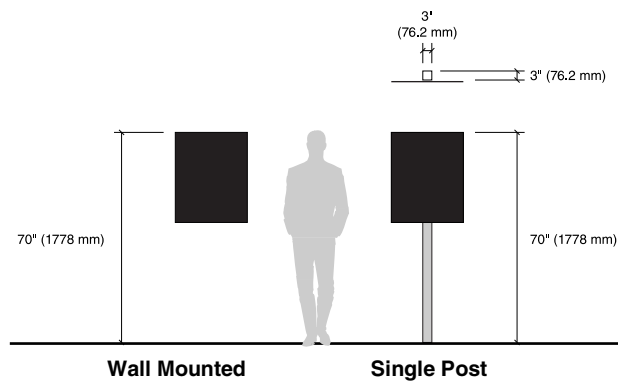

IN-02.06

Mandatory VA Policy & Directive Signage Drawings

Parking Restrictions Sign

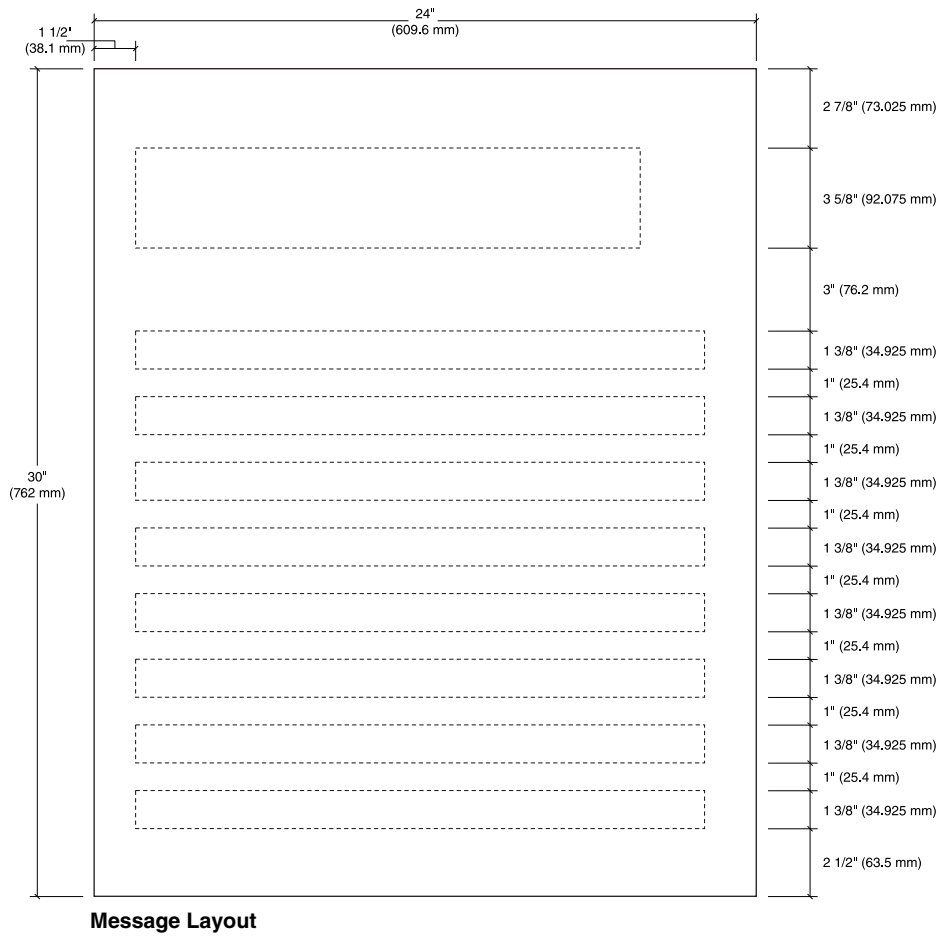

IN-02.07.01

Mandatory VA Policy & Directive Signage Drawings

Rights and Responsibilities of VA Patients

Size

Display Window to Accommodate VA Supplied Poster

36" High x 24" Wide
(914.4 mm H x 609.6 mm W)

Description

Patient rights and responsibilities sign required at the main entrance/lobby of all buildings where patient care is provided.

Sign Components

Sign frame/case with acrylic or glass cover to accommodate VA supplied poster. Options to include front-loading snap/spring loaded frame or swing frame. See [Section 2.3.3](#) for additional details.

Graphic Process

VA provided poster

Colors

Frame to match or complement any existing or designated color and material palette.

Refer to the chart in the Appendix.

Mounting

Concealed mechanical fasteners adequate for weight and wall type

Installation

Coordinate placement with other policy signs required at entrances.

See [example layouts](#) at the end of this section.

Recommendations

If conditions do not allow for a poster of this size, the VA approved design can be scaled down to a minimum poster size of 24" x 18". Avoid warping or altering the artwork in any way.



Message Layout

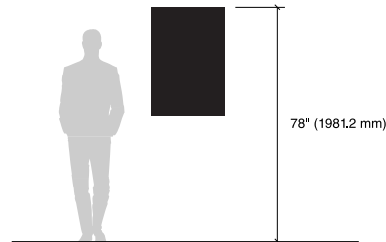

Adjust installation height as needed to coordinate with other policy signs.



IN-02.07.01

Mandatory VA Policy & Directive Signage Drawings

Rights and Responsibilities of VA Patients

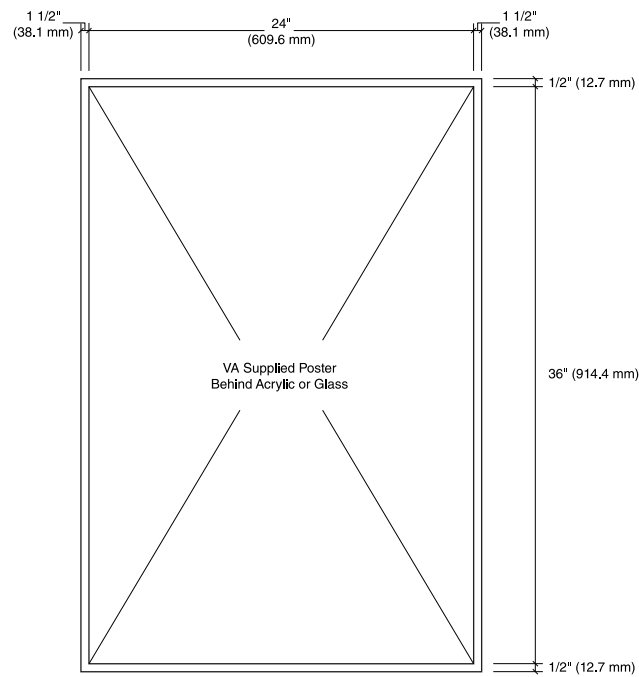

Message Layout



IN-02.07.02

Mandatory VA Policy & Directive Signage Drawings

Rights and Responsibilities of Family Members of VA Patients

Size

Display Window to Accommodate
VA Supplied Poster

36" High x 24" Wide
(914.4 mm H x 609.6 mm W)

Description

Family member rights and responsibilities sign required at the main entrance/lobby of all buildings where patient care is provided.

Sign Components

Sign frame/case with acrylic or glass cover to accommodate VA supplied poster. Options to include front-loading snap/spring loaded frame or swing frame. See [Section 2.3](#) for additional details.

Graphic Process

VA provided poster

Colors

Frame to match or complement any existing or designated color and material palette.

Refer to the chart in the Appendix.

Mounting

Concealed mechanical fasteners adequate for weight and wall type

Installation

Coordinate placement with other policy signs required at entrances.

See [example layouts](#) at the end of this section

Recommendations

If conditions do not allow for a poster of this size, the VA approved design can be scaled down to a minimum poster size of 24" x 18". Avoid warping or altering the artwork in any way.



Message Layout

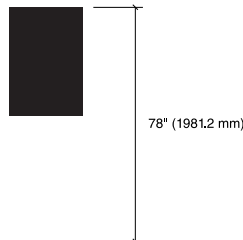

Adjust installation height as needed to coordinate with other policy signs.



Rights and Responsibilities of Family Members of VA Patients

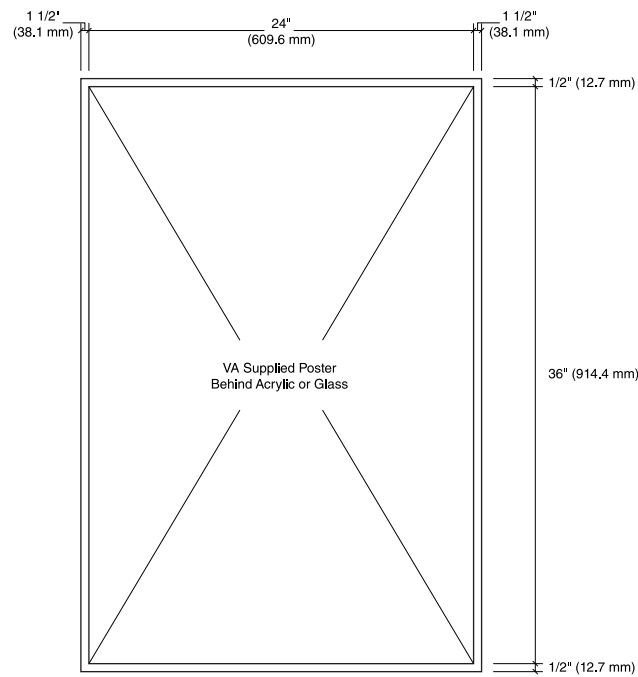

Message Layout



IN-02.07.03

Mandatory VA Policy & Directive Signage Drawings

Policies and Directives

Size

Display Window to Accommodate
VA Supplied Poster:
30" High x 18" Wide
(762 mm H x 457.2 mm W)

Description

Policies and Directives (VA Form 0088) required at the main entrance/lobby of all buildings where patient care is provided.

Sign Components

Sign frame/case with acrylic or glass cover to accommodate VA supplied poster. Options to include front-loading snap/spring loaded frame or swing frame. See [Section 2.3.3](#) for additional details.

Graphic Process

VA provided poster

Colors

Frame to match or complement any existing or designated color and material palette.

Refer to the chart in the Appendix.

Mounting

Concealed mechanical fasteners adequate for weight and wall type

Installation

Coordinate placement with other policy signs required at entrances.

See [example layouts](#) at the end of this section.

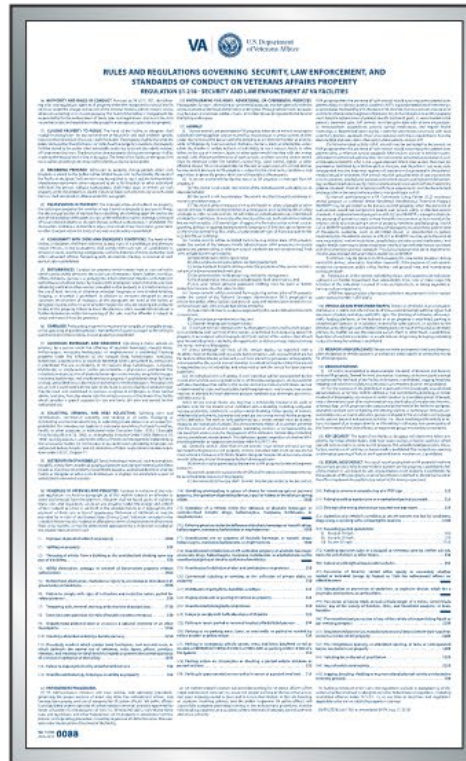

Message Layout

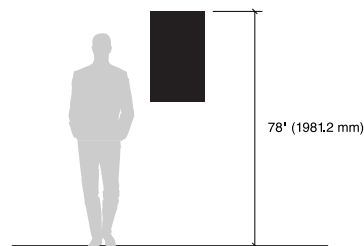

Adjust installation height as needed to coordinate with other policy signs.



IN-02.07.03

Mandatory VA Policy & Directive Signage Drawings

Policies and Directives

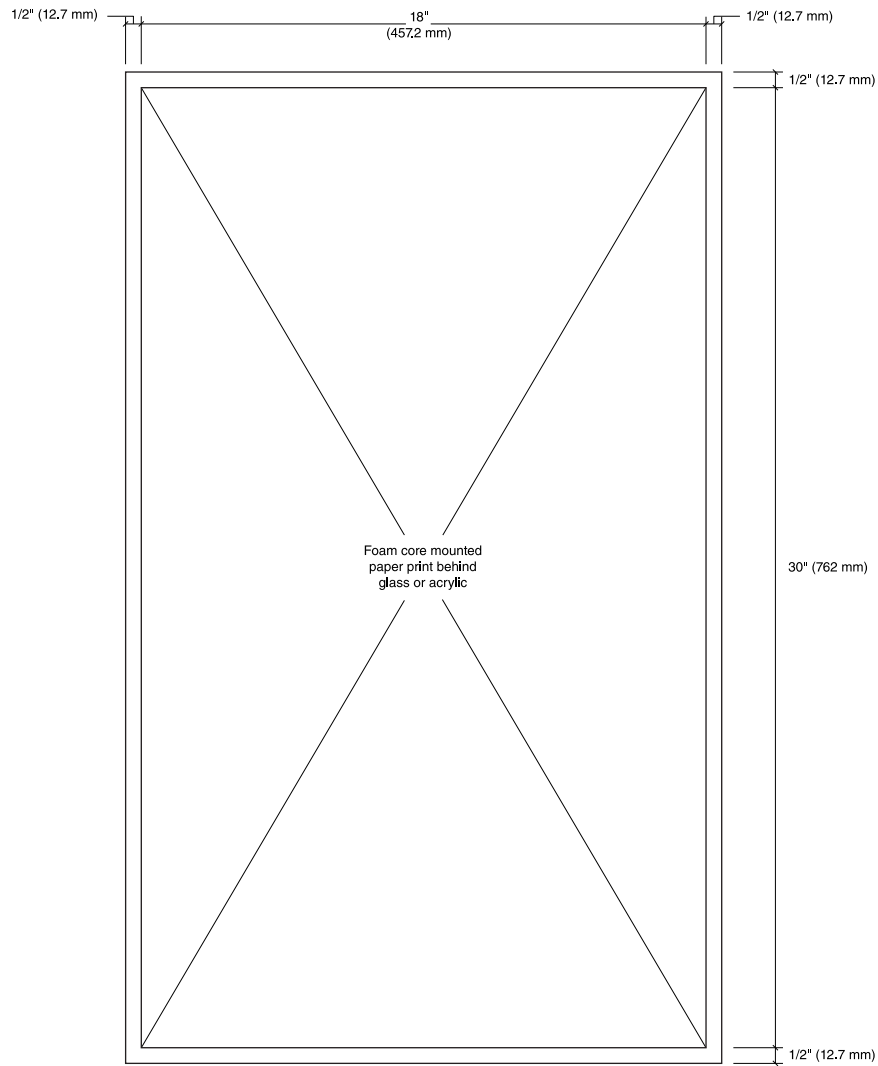

Message Layout



IN-02.07.04

Mandatory VA Policy & Directive Signage Drawings

Notice of Privacy Practices

Size

Display Window to Accommodate
VA Supplied Poster:
39" High x 26 3/4" Wide
(990.6 mm H x 679.45 mm W)

Description

Notice of Privacy Practices sign required in a prominent location(s) where it is reasonable to expect that individuals seeking service will be able to read the Notice of Privacy Practices (e.g., Release of Information (ROI) Office, Eligibility Office, Employee Health Office).

Sign Components

Sign frame/case with acrylic or glass cover to accommodate VA supplied poster. Options to include front-loading snap/spring loaded frame or swing frame. See [Section 2.3.3](#) for additional details.

Graphic Process

VA provided poster

Colors

Frame to match or complement any existing or designated color and material palette.

Refer to the chart in the Appendix.

Mounting

Concealed mechanical fasteners adequate for weight and wall type

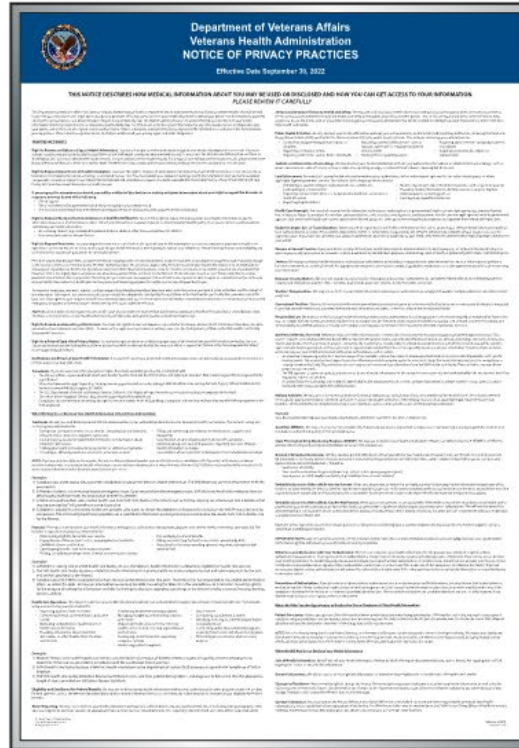

Message Layout

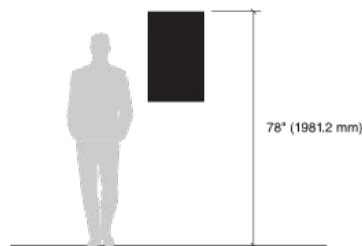

IN-02.07.04

Mandatory VA Policy & Directive Signage Drawings

Notice of Privacy Practices

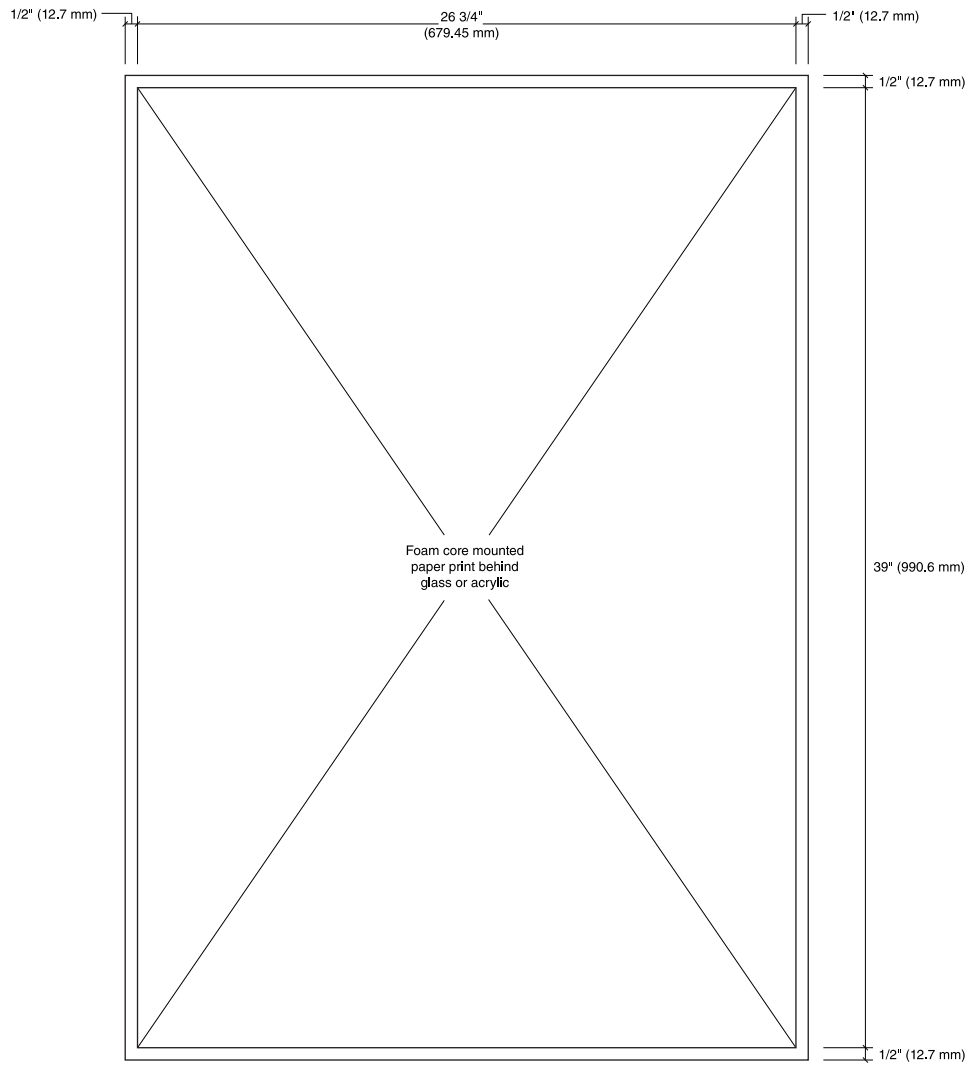

Message Layout



IN-02.08

Mandatory VA Policy & Directive Signage Drawings

Anti-Sexual Harassment / Anti-Sexual Assault

Size

Display Window to Accommodate
VA Supplied Poster
Available in Two Sizes:

Message Layout A
17" High x 11" Wide
(431.8 mm H x 279.4 mm W)

Message Layout B
24" High x 18" Wide
(609.6 mm H x 457.2 mm W)

Description

Anti-Sexual Harassment / Assault
posting required to be displayed in
prominent spaces (such as lobbies
or other gathering areas).

Sign Components

Sign frame/case with acrylic cover
to accommodate VA supplied
poster. Options to include front-
loading snap/spring loaded frame or
acrylic pocket. See [Section 2.3.3](#) for
additional details.

Graphic Process

VA provided poster

Colors

Frame to match or complement any
existing or designated color and
material palette.

Refer to the chart in the Appendix.

Mounting

Concealed mechanical fasteners
adequate for weight and wall type

Installation

Coordinate placement with other
policy or VHA Directive postings to
avoid visual clutter or a disjointed
appearance.

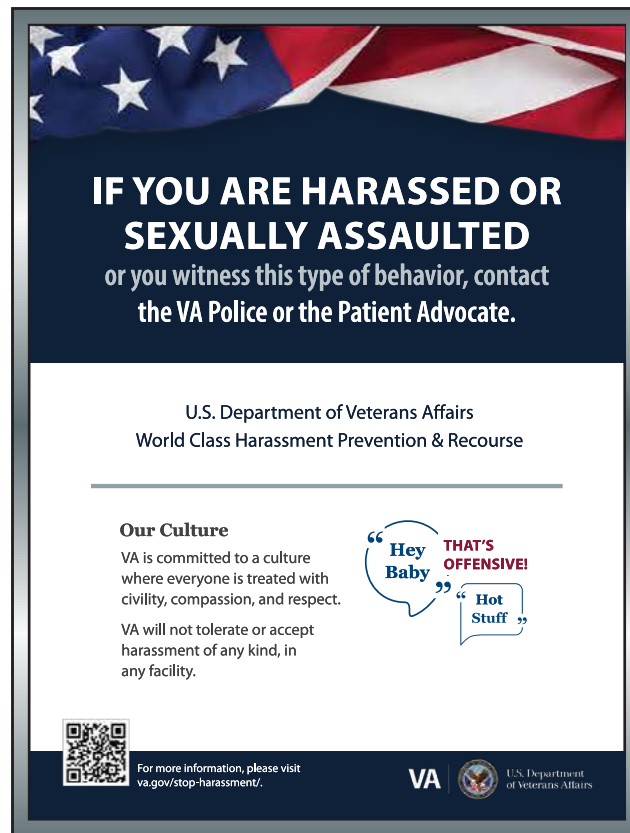

Message Layout

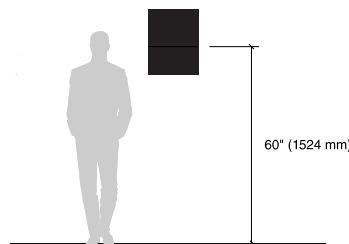

Adjust installation height as needed to
coordinate with other policy signs.



IN-02.08

Mandatory VA Policy & Directive Signage Drawings

Anti-Sexual Harassment / Anti-Sexual Assault

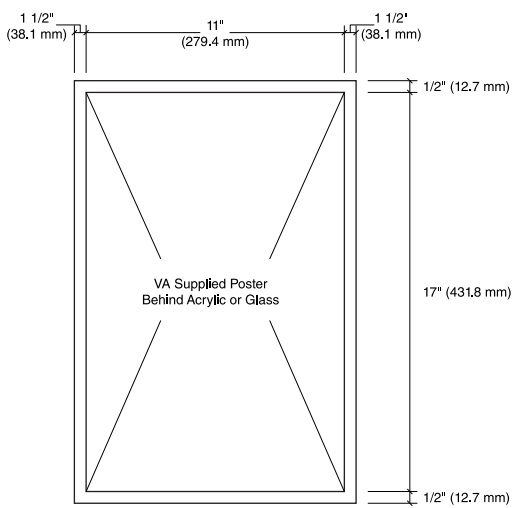

Message Layout A

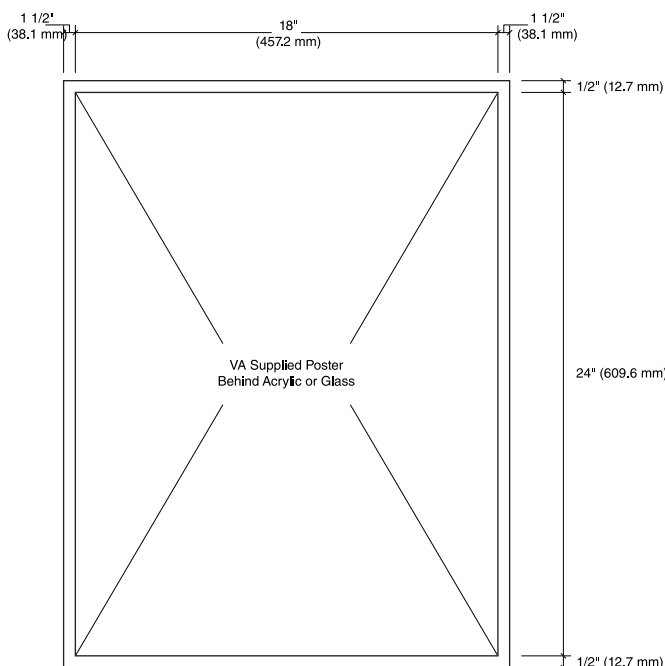

Message Layout B



IN-02.10

Mandatory VA Policy & Directive Signage Drawings

No Weapons Notice Sign - Interior

Size

Sign Face:
6" High x 20" Wide
(152.4 mm H x 508 mm W)

Description

No weapons sign to be placed on an interior wall at all public entrances to a building.

Message Configuration

Refer to message layout drawing for dimensions.

Sign Components

Component based sign system

Graphic Process

Direct digital print on second surface or silk-screened

Colors

Background: White
Graphics: Red, White, Blue, and Black

Refer to the chart in the Appendix.

Typography

Helvetica Bold

Mounting

Preferred: Concealed mechanical fasteners
Alternate: Double-sided VHB foam tape and silicone adhesive

Installation

Display the 6" x 20" policy signs in the following sequence:

- IN-02.01 - Consent to Inspection
- IN-02.10 - No Weapons Notice
- IN-02.03 - No Weapons Policy

- IN-02.14 – Video Surveillance
- IN-02.15 – Service Dogs
- IN-02.02 – No Smoking, No Vaping

These signs can be grouped together in one display or broken into two displays of 3 signs each, following the same sequence.

Coordinate placement with other policy signs required at entrances.

See [example layouts](#) at the end of this section.

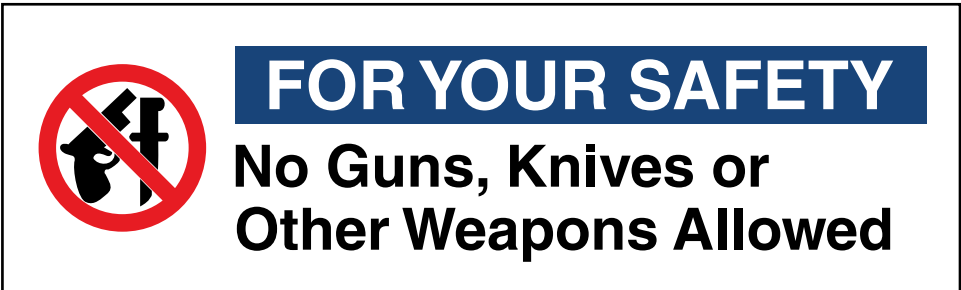

English Version



Spanish Version

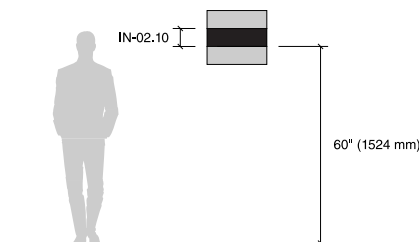

Adjust installation height as needed to coordinate with other policy signs.



IN-02.10

Mandatory VA Policy & Directive Signage Drawings

No Weapons Notice Sign - Interior

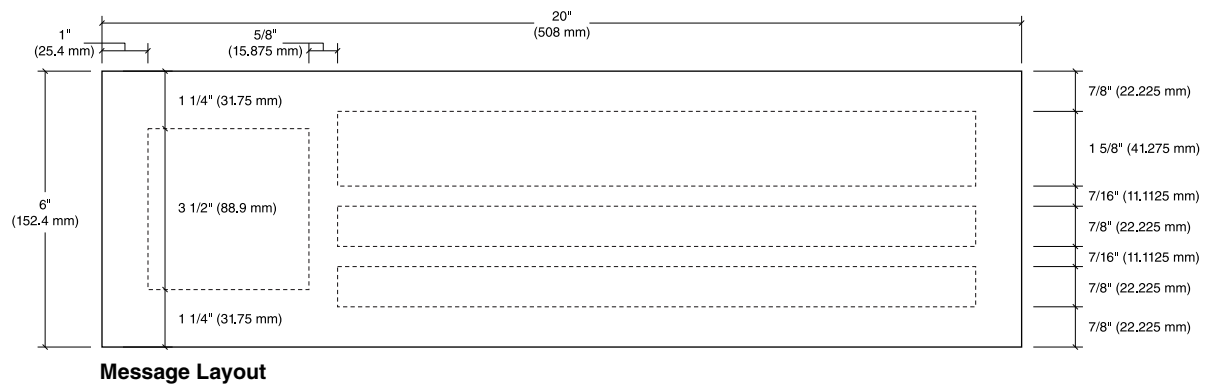

IN-02.11

Mandatory VA Policy & Directive Signage Drawings

No Weapons Sign Large - Exterior

Size

Sign Face:
30" High x 24" Wide
(762 mm H x 609.6 mm W)

Description

No weapons sign to be placed at all exterior entrances to VA property.

Message Configuration

Refer to message layout drawing for dimensions.

Sign Components

Aluminum sign panel

Graphic Process

Silk-screened or surface applied vinyl

Colors

Background: White
Graphics: Red, White, Blue, and Black
Refer to the chart in the Appendix.

Typography

Helvetica Bold
Helvetica Bold Italic

Installation

Position signs so drivers have a clear, unobstructed view of the sign.

Install IN-02.13 Video Surveillance Sign below IN-02.11.

When placing this type of sign near curbs or parking places, be sure the sign is set far enough back that over hanging front and rear of automobiles do not come in contact with the signpost.



English Version



Spanish Version

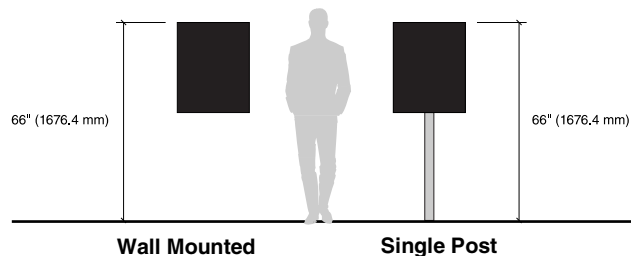

IN-02.11

Mandatory VA Policy & Directive Signage Drawings

No Weapons Sign Large - Exterior

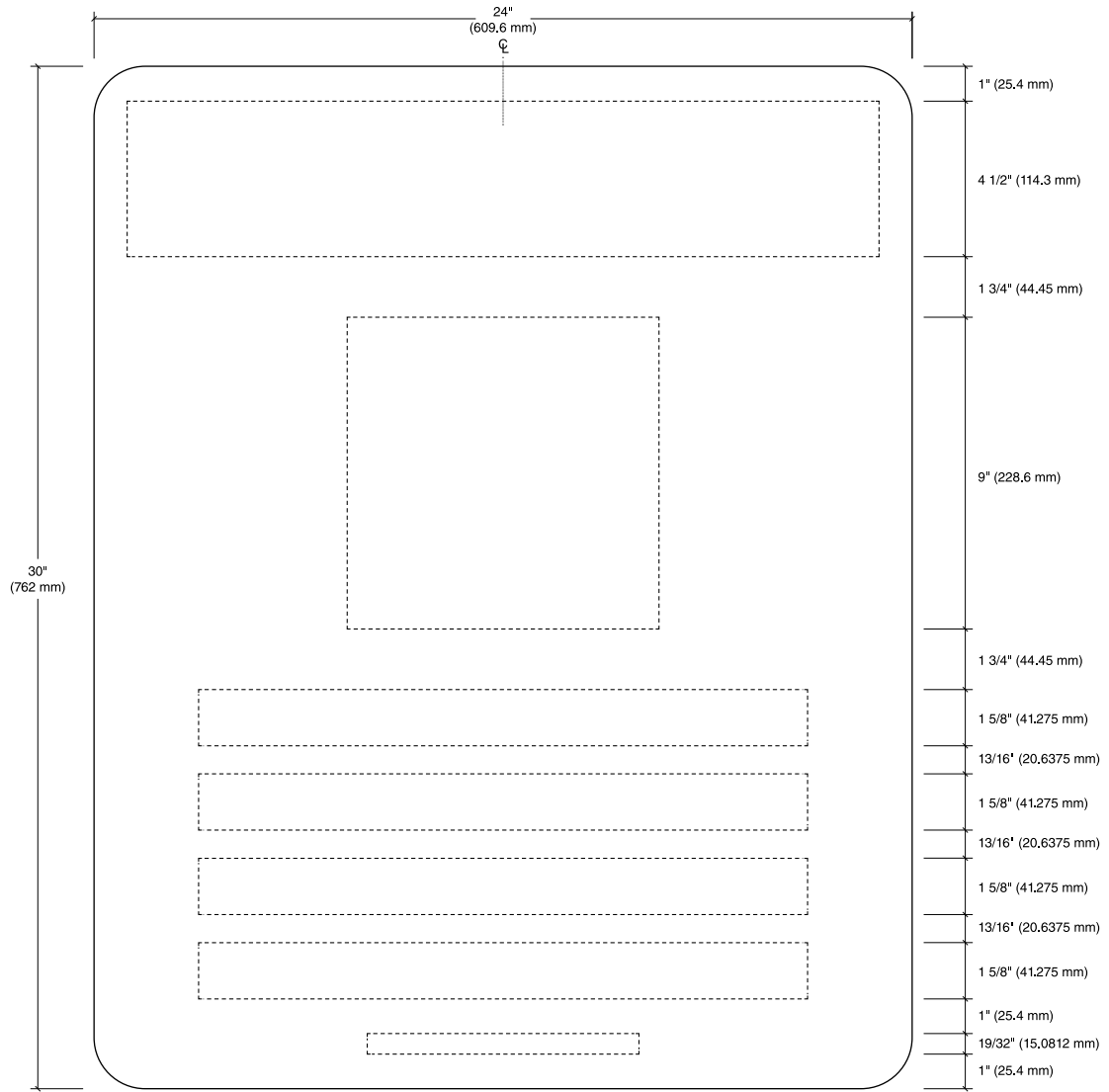

Message Layout



IN-02.12

Mandatory VA Policy & Directive Signage Drawings

No Weapons Sign Small - Exterior

Size

Sign Face:
24" High x 18" Wide
(609.6 mm H x 457.2 mm W)

Description

Small Exterior "No Weapons" sign for limited spaces with pedestrian visibility.

Message Configuration

Refer to message layout drawing for dimensions.

Sign Components

Aluminum sign panel

Graphic Process

Silk-screened or surface applied vinyl

Colors

Background: White
Graphics: Red, White, Blue, and Black
Refer to the chart in the Appendix.

Typography

Helvetica Bold

Installation

Position signs so pedestrians have a clear, unobstructed view of the sign. Install IN-02.13 Video Surveillance Sign below IN-02.12. When placing this type of sign near curbs or parking places, be sure the sign is set far enough back that over hanging front and rear of automobiles do not come in contact with sign post.



English Version



Spanish Version

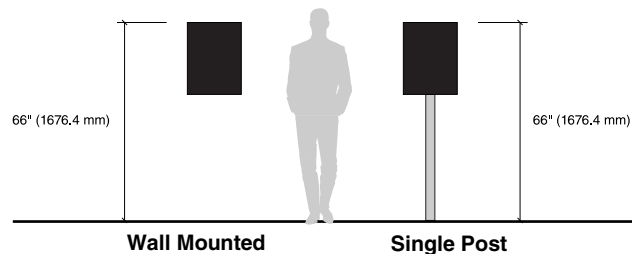

IN-02.12

Mandatory VA Policy & Directive Signage Drawings

No Weapons Sign Small - Exterior

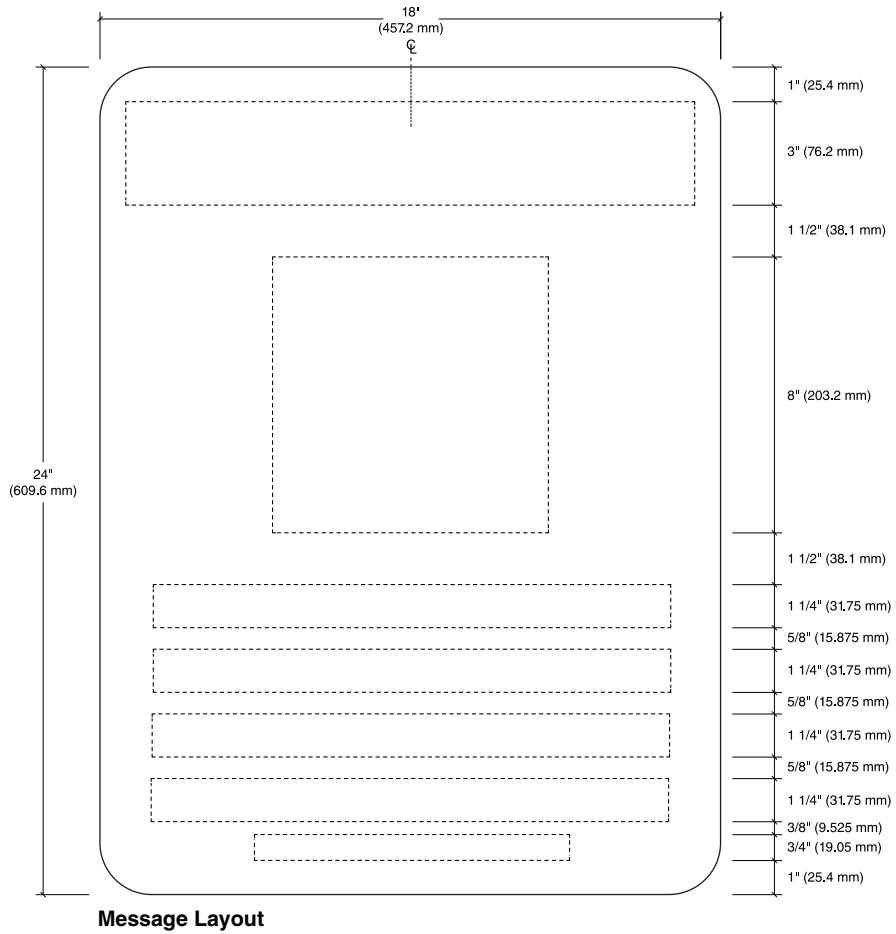

IN-02.13

Mandatory VA Policy & Directive Signage Drawings

Video Surveillance Sign - Exterior

Size

Message Layout A:
6" High x 24" Wide
(152.4 mm H x 609.6 mm W)

Message Layout B:
6" High x 18" Wide
(152.4 mm H x 457.2 mm W)

Description

Exterior video surveillance sign to be placed at all exterior entrances to VA property and other locations deemed necessary.

Message Configuration

Refer to message layout drawing for dimensions.

Sign Components

Aluminum sign panel

Graphic Process

Silk-screened or surface applied vinyl

Colors

Refer to the chart in the Appendix.

Typography

Helvetica Bold

Installation

Position so there is a clear, unobstructed view of the sign. Install below exterior no weapons sign IN-02.11 or IN-02.12 and in other locations deemed necessary.

Message Layout A

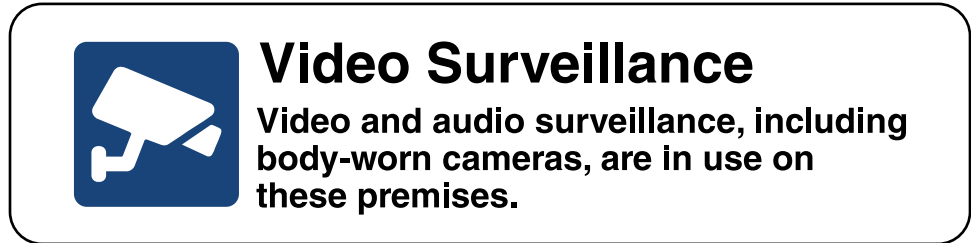

Message Layout B

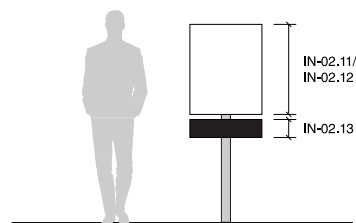
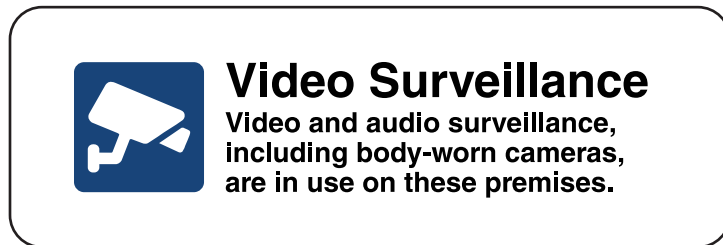

IN-02.13

Mandatory VA Policy & Directive Signage Drawings

Video Surveillance Sign - Exterior

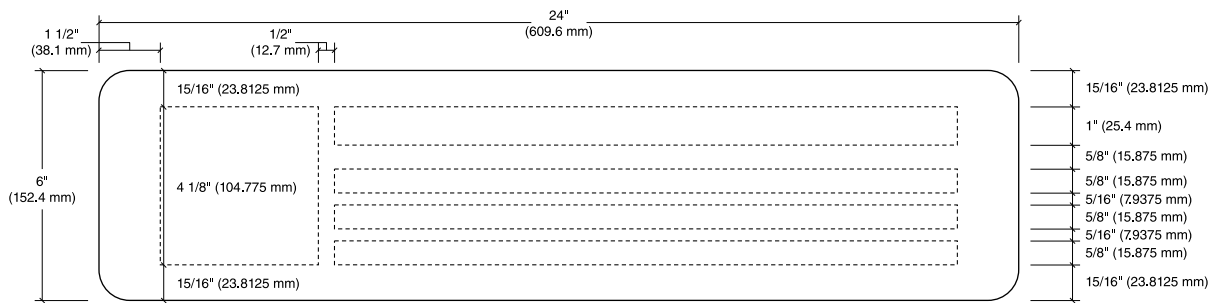

Message Layout A

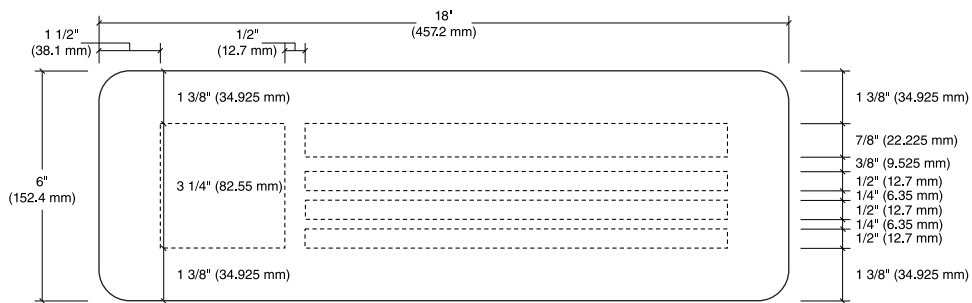

Message Layout B



IN-02.14**Mandatory VA Policy & Directive Signage Drawings****Video Surveillance Sign****Size**

6" High x 20" Wide
(152.4 mm H x 609.6 mm W)

Description

"Video Surveillance Sign" is required to be placed on an interior wall at all public entrances to a building.

Message Configuration

Refer to message layout drawing for dimensions. When combining 6" x 20" policy signs into one display, add a 1/16" rule line to separate each sign visually.

Sign Components

Component based sign system

Graphic Process

Direct digital print on second surface or silk-screened

Colors

Refer to the chart in the Appendix.

Typography

Helvetica Bold

Mounting

Preferred: Concealed mechanical fasteners

Alternate: Double-sided VHB foam tape and silicone adhesive

Installation

Display the 6" x 20" policy signs in the following sequence:

-IN-02.01 - Consent to Inspection
-IN-02.10 - No Weapons Notice
-IN-02.03 - No Weapons Policy

-IN-02.14 – Video Surveillance
-IN-02.15 – Service Dogs
-IN-02.02 – No Smoking, No Vaping

These signs can be grouped together in one display or broken into two displays of 3 signs each, following the same sequence.

Coordinate placement with other policy signs required at entrances.

See [example layouts](#) at the end of this section.

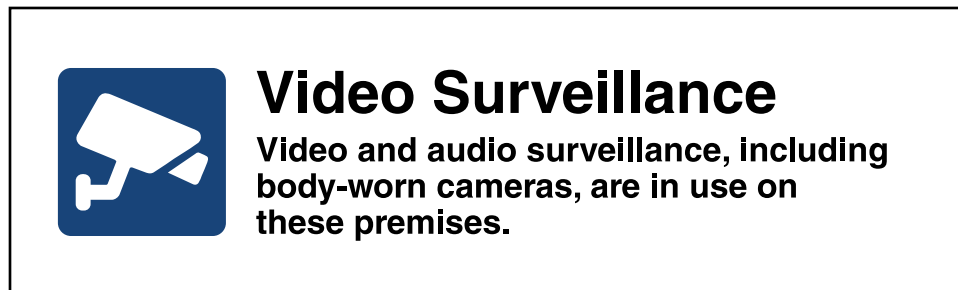

Message Layout

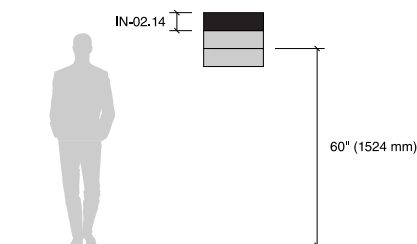

IN-02.14

Mandatory VA Policy & Directive Signage Drawings

Video Surveillance Sign

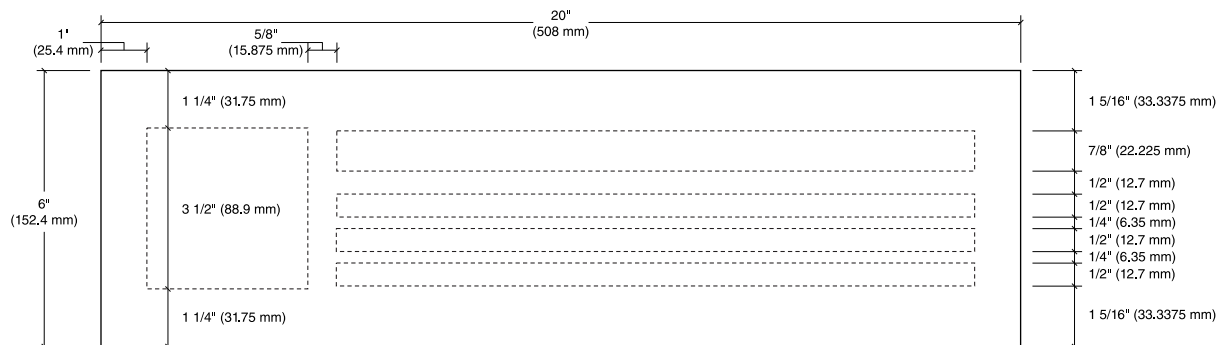

Message Layout



IN-02.15**Mandatory VA Policy & Directive Signage Drawings****Service Dogs Sign****Size**

6" High x 20" Wide
(152.4 mm H x 609.6 mm W)

Description

"Service Dogs Sign" can be placed on an interior wall at all public entrances to a building with other policy signs. At the time of publishing, this sign is NOT required.

Message Configuration

Refer to message layout drawing for dimensions. When combining 6" x 20" policy signs into one display, add a 1/16" rule line to separate each sign visually.

Sign Components

Component based sign system

Graphic Process

Direct digital print on second surface or silk-screened

Colors

Refer to the chart in the Appendix.

Typography

Helvetica Bold

Mounting

Preferred: Concealed mechanical fasteners

Alternate: Double-sided VHB foam tape and silicone adhesive

Installation

Display the 6" x 20" policy signs in the following sequence:

-IN-02.01 - Consent to Inspection
-IN-02.10 - No Weapons Notice
-IN-02.03 - No Weapons Policy

-IN-02.14 – Video Surveillance
-IN-02.15 – Service Dogs
-IN-02.02 – No Smoking, No Vaping

These signs can be grouped together in one display or broken into two displays of 3 signs each, following the same sequence.

Coordinate placement with other policy signs required at entrances.

See [example layouts](#) at the end of this section.



Message Layout

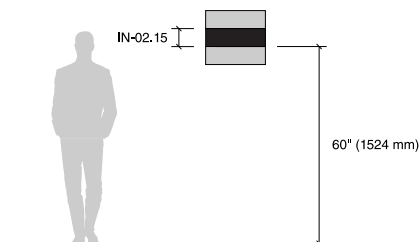

IN-02.15

Mandatory VA Policy & Directive Signage Drawings

Service Dogs Sign

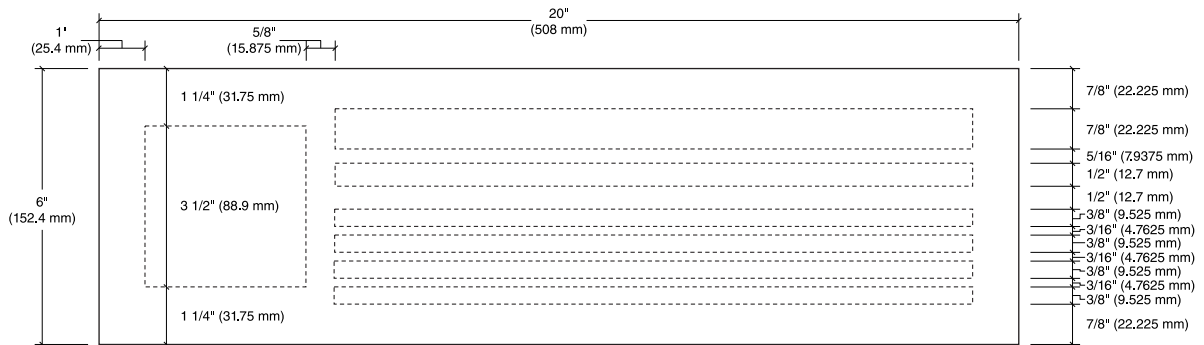

Message Layout



IN-02.16

Mandatory VA Policy & Directive Signage Drawings

No Trespassing Sign

Size

Sign Face:
12" High x 18" Wide
(304.8 mm H x 457.2 mm W)

Description

No trespassing sign to be placed at all exterior entrances to VA property.

Message Configuration

Refer to message layout drawing for dimensions.

Sign Components

Aluminum sign panel

Graphic Process

Silk-screened or surface applied vinyl

Colors

Background: White/Blue
Text: Black/White
Refer to the chart in the Appendix.

Typography

Helvetica Bold

Installation

Position signs so drivers and pedestrians have a clear, unobstructed view of the sign.

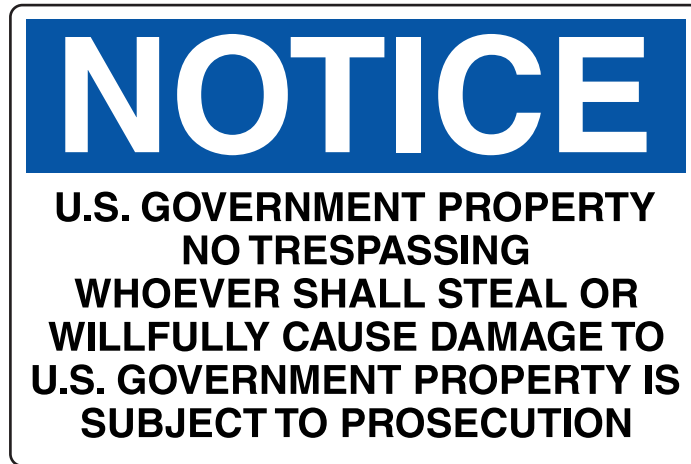

Message Layout

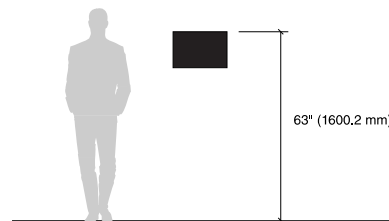

IN-02.16

Mandatory VA Policy & Directive Signage Drawings

No Trespassing Sign

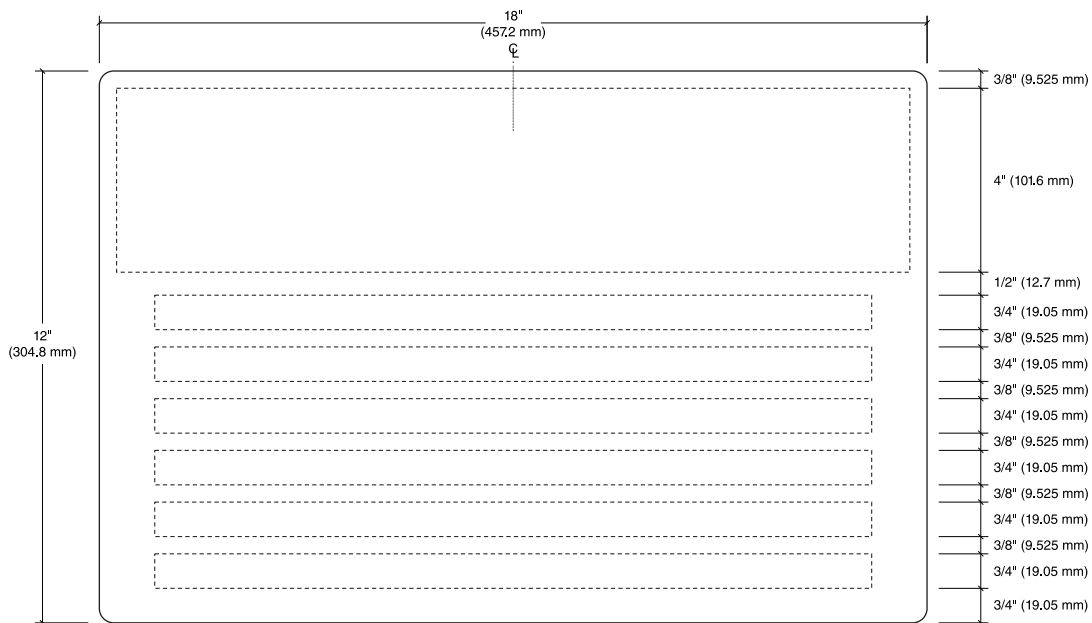

Message Layout



Layout

Description

The designs are based on mandatory postings required at the main entrances/lobbies of all buildings where patient care is provided. At secondary public entrances, only the following sign types are required: IN-02.01 Consent to Inspection, IN-02.10 No Weapons Notice, IN-02.03 No Weapons Policy, IN-02.14 Video Surveillance, and IN-02.02 No Smoking/Vaping.

Installation

When placing signs near each other, it is important to consider how all components will work together as a cohesive whole. The following layouts provide examples of how entrance policy signs can be coordinated with other design elements to welcome visitors and clearly communicate important messages.

The graphic panels incorporated into the design can be used in various ways. For wayfinding, they can help reinforce the name of the entrance, facility, area/zone, or building number. Other options include a welcome message or military emblems combined with inspiring imagery.

Mount message configuration on wall at 60" (1524 mm) to center.

Mandatory VA Policy & Directive Signage Drawings

Layout Examples for Mandatory Entrance Signs

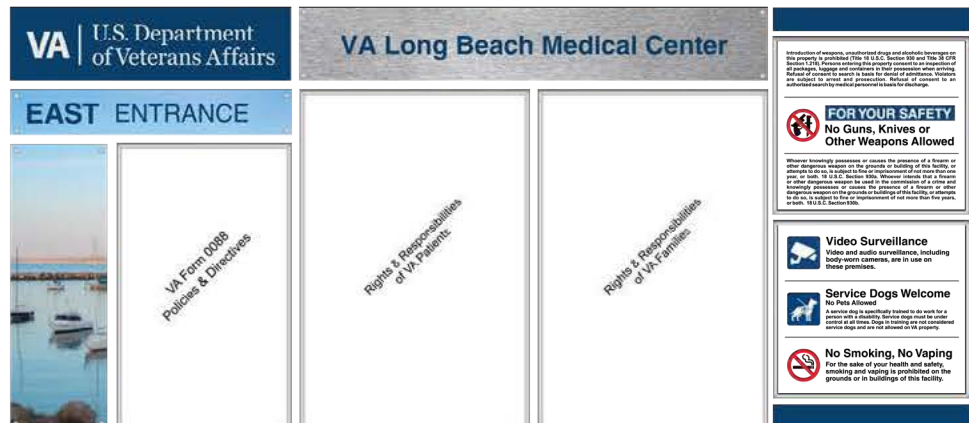

Layout A

This layout has three separate header panels allowing the concept to be divided into two or three sections if there is limited wall space. In this example, the 6" x 20" policy signs are separated into two displays of 3 signs each following the prescribed sequence.



Layout B

This layout has two header panels and combines all 6" x 20" policy signs into one display for a more streamlined approach if there is adequate wall space.



Layout C

This layout has three separate header panels allowing the concept to be divided into two or three sections if there is limited wall space. At secondary public entrances the far-left section, which comprises of the VA Logo, image panel and 6" x 20" policy signs, can be used independently.



Layout **Mandatory VA Policy & Directive Signage Drawings**

Layout Examples for Mandatory Entrance Signs

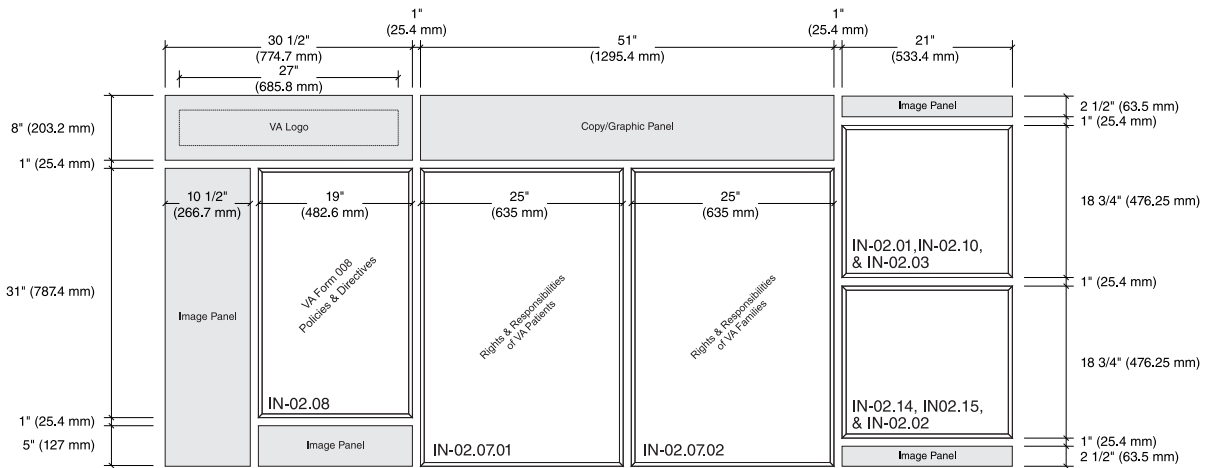

Layout A

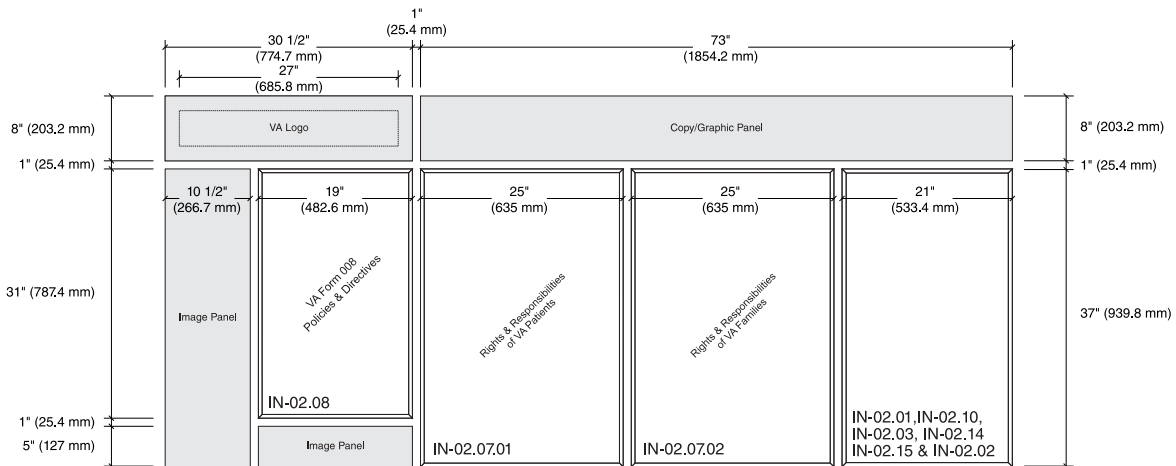

Layout B

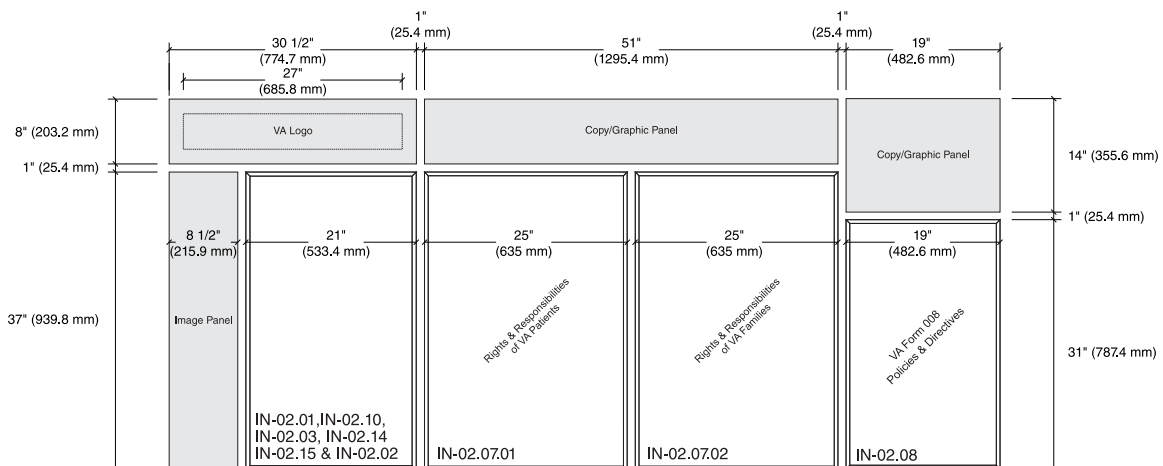

Layout C

